

Superkart Technical Regulations

v1.1 2023

Quick Weight & Plate Reference

250cc International	218kg
250cc National	208kg
125cc Open	195kg
125cc Stock Honda	180kg
125cc NGB Super Heavy	205kg* <small>*Maximum kart only weight of 105kg</small>
125cc NGB Heavy	185kg* <small>*Maximum kart only weight of 105kg</small>
125cc NGB Light	165kg
125cc NGB Junior	140kg

Superkart Technical Regulations

Classes will be designated the following lettering scheme.

Open Classes

- A:** 250cc International
- B:** 250cc National
- C:** 125cc Gearbox Open

Control Classes

- D:** 125cc Stock Honda
- E:** 125cc Non Gearbox

Classes will be designated the following Category numbering scheme at all times.

- 1.** Chassis
- 2.** Controls
- 3.** Seat
- 4.** Floor Tray
- 5.** Bodywork
- 6.** Brakes
- 7.** Wheels & Tyres
- 8.** Weight
- 9.** Numbers
- 10.** Cooling
- 11.** Fuel
- 12.** Transmission
- 13.** Engine

Technical Regulations

- F:** Fuel
- G:** Apparel + CIK/FIA Approved Race Suits



250cc ***INTERNATIONAL***

250cc INTERNATIONAL

A1: Chassis

IDENTIFICATION:

Each chassis must be marked with a unique identification number/code in a visible position on a non-removable main rail or member. This number/code shall be by permanent incident or impression of numerical and/or alpha characters and shall be recorded in the kart's log book.

DIMENSIONS:

- The wheelbase must be at least 1000mm and not more than 1270mm.
- The track must be at least two-thirds of the wheelbase.
- The overall length must not exceed 2400mm.

CONSTRUCTION:

The frame must be of all metal construction.

TRANSPONDER:

Timing transmitters when fitted shall be located with the whole of the unit and mounting behind the front axle centreline in the straight ahead position with nothing metallic between the transponder and the ground.

BUMPERS:

Each kart must be fitted with bumpers front and rear. No component of the kart (other than the front fairing) may extend past either the front or rear bumpers, but may be mounted on or attached to the bumpers.

Front bumpers must be rigid, positioned forward of the feet and mounted at the line of or forward of the front chassis rail. They may consist of single or parallel tubes, and attached fixings, tabs, brackets and supports for the front fairing are allowed.

The bumper must be; a minimum diameter of 16 mm Steel tubing and have a minimum wall thickness of 1.5 mm, and be mounted horizontally at a line perpendicular to the centre line of the kart and at a height no less than half way up the driver's feet when seated. Front bumpers shall have a minimum of four mountings to the main chassis placed with two either side of the front central point extremities and two at the side return ends. Front Bumper height shall not be adjustable in any way while the vehicle is in motion. Any support arms and struts shall be tubular with minimum 15mm radius edges, and have no sharp or angular points at the extremities.

Each rear bumper shall be composed of at least one bar with a minimum diameter of 18mm and a minimum wall thickness of 1.5mm in the area between the chassis main rails; the lowest bar shall be located at a height to ground not exceeding 170mm. The rear bumper unit must be fixed to the chassis frame in at least two points.

Rear wheel protection is mandatory. Minimum width shall be 1,080mm, the rear bumper maximum width shall not exceed the dimension between the outer flanges of the rear wheels regardless of the rear track setting.

Rear bumper overhang shall not exceed 400mm behind the rear axle centreline. The outer ends must be located behind the rear wheels, and:

- Any support struts or bars shall not have sharp or angular parts at the extremities;
- The outer ends shall comprise a minimum 120° tubular bending with a minimum radius of 50mm that returns back to the mounting leaving no exposed tube end/s;
- May be fitted in an angled, horizontal or vertical plane;
- The rear wheel protection bar/s shall be located within an area between 80mm and 260mm height to the ground.

250cc INTERNATIONAL

Side Bumpers must be fitted to both outside faces of the chassis-frame main rail to cover the area behind the front wheel and forward of the rear wheel and must consist in at least 2 steel elements:

- a steel tube upper bar mounted above a steel tube lower bar,- all with a minimum diameter of 16mm Steel tubing and have a minimum wall thickness of 1.5mm,
- both bars must be connected, with a minimum of at least one additional intermediate support tube, and welded together, and presenting a vertical flat face.

Minimum length of the bars parallel to ground: 500mm for the lower bar, 400mm for the upper bar.

Height of the lower bar: 50 +/-20mm from the ground.

Height of the upper bar: 200 +/-20mm from the ground.

The upper bar shall return on to and connect to the lower bar generally as follows: at the front the return end is to angle inwards to a point no less than 100mm from the bottom bar outer face line, and at the rear the return end may be angled as per the front, or return to the bottom bar at the face line no less than 120mm forward of the rear wheel tread face.

Side Bumpers shall have at least one intermediate support between upper and lower bars of the same spec material.

Each side bumper assembly must be attached to the chassis-frame main rail by 2 points minimum. These 2 attachments must be parallel to the ground and they must be 500mm minimum apart.

Side Bumpers may be formed to replicate side pod shapes that taper inward behind the front wheels, and shall cover a minimum of two-thirds of the tread width of the dry(slick) rear tyres and front tyres while positioned at the straight ahead position.

Side bumpers within side pods of non-quadrilateral outer face shape including 'wedge' styles must conform to the preceding, save that any portion of the upper bar unable to be placed parallel to ground and below 200mm +/- 20mm from the ground must replicate that side pod outer face upper extremity shape.

DIMENSION	LETTER	VALUE
CHASSIS MOUNTS	A	500mm (min)
GROUND CLEARANCE	B	50mm ± 20mm
TUBE DIAMETER	C	16mm x 1.5mm (min)
LOWER SECTION PARALLEL TO GROUND	D	500mm (min)
UPPER SECTION PARALLEL TO GROUND	E	400mm (min)
HEIGHT OF UPPER BAR	F	200mm ± 20mm
UPPER BAR RETURN POINT	G	100mm (min)
UPPER BAR REAR RETURN POINT	H	120mm (max)
CLEARANCE TO FRONT WHEEL	I	150mm (max)

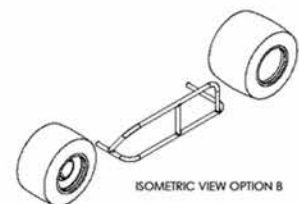
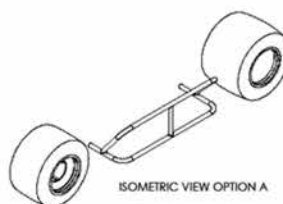
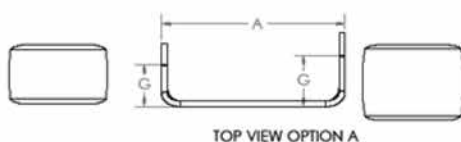
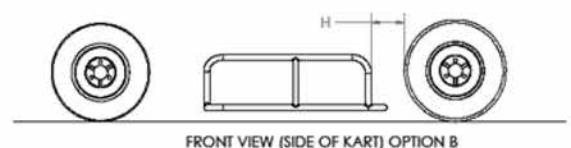
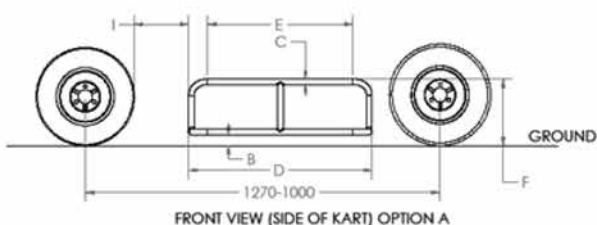

SUSPENSION:

Any suspension device is prohibited.

250cc INTERNATIONAL

A2: Controls

PEDALS:

Whatever the position of the pedals, they must not protrude forward of the chassis, including the bumper.

THROTTLE:

The throttle must be operated by a pedal equipped with a return spring.

The carburettor must incorporate a throttle return spring.

****Hand controls:**

For the operation of the throttle and brakes are subject to the approval of the MA Technical Department. Such controls shall be identified in the kart's Log Book. These controls shall only be permitted for use by Competitors with individual disabilities.

STEERING:

Steering must be effected by the operation of a full wheel or aircraft type wheel, which has a full metal frame.

Straight handle-bars are forbidden.

Commercially available detachable steering wheels and mounts are permitted provided that they meet all other requirements.

Steering stops may be fitted.

The steering must be direct acting through a steel steering shaft of at least 16mm diameter if solid; or 19mm diameter if tubular having a minimum wall thickness of 2mm for steering wheel attachment.

The steering wheel boss must be manufactured of metal. Solid material, e.g., nylon or hardwood, must be inserted through the steering column where the steering boss bolt passes through, in order to prevent the column collapsing when the bolt is tightened. The steering shaft shall have a failsafe system to prevent it being pulled from the lower bush or bearing. All steering linkage assembly bolts and nuts must be cottered, lock wired, or fitted with self-locking nuts (including king pin bolts).

The tie rods must be of at least 8mm OD steel rod, 10mm OD by 2mm steel tube, or 10mm OD aluminium rod, or 12mm OD by 2.6mm aluminium alloy tube. In all female components of all steering rod ends and steering tie rods, there must be an inspection hole of 1mm diameter drilled 8mm from the open end. When assembled the inspection hole must be covered by thread.

All bolts must be of at least 6mm diameter, of high tensile steel with a shear strength of not less than 6KN. All tie rods must have "Rose" joints or similar aircraft type universal joints.

CLUTCH AND GEAR SHIFT LEVERS:

Gear and clutch, levers or paddles shall be positioned behind the steering wheel when viewed from the Drivers position, so that they are within fingertip reach from the steering wheel. Gear and Clutch control by steering wheel mounted activation buttons of electric, electronic, servo, pneumatic or pressure line systems is permitted. Further, foot operated clutch pedal situated left of the centre mounted brake pedal is permitted.

SWITCHES:

Each Superkart shall be equipped with an isolation (master) switch which effectively isolates all electrical circuits from the battery and stops the engine. Switches shall be capable of being operated by the seated Driver and from outside the automobile. These switches shall be clearly marked by a symbol showing a red spark in a white-edged blue triangle shown on the bodywork outer surface.



Control switches for electrically powered devices and accessories must be located forward of the Drivers elbow in the normal seated driving position, and be accessible to trackside officials with the Driver seated. The allowable mounting areas are confined to; an area beside the forward part of the seat; the Nassau panel/ bubble area; or on the steering wheel. Switches may be toggle, slide or push-pull type, and shall be individually identified as to on/off position and function. Grouped switches shall be arranged so that all are 'off' and 'on' in the same direction or position.

RAIN LIGHTS:

Rain lights are mandatory for Superkarts. They shall be a unit approved by the FIA or CIK. Tail lights must be powered by a sealed battery and controlled from the cockpit by a waterproof switch. The centre point of the light face must be in an area located 350-600mm from the ground and not more than 100mm either side of the centre line of the kart.

It must be in working condition throughout the meeting. It must be switched on when the race is declared "wet" by the Clerk of the Course or when wet weather tyres are fitted.

A3: Seat

The seat must be so designed that the Driver is well located to resist movement towards the side or front when cornering or braking. It must be firmly attached to the frame by at least four mountings of adequate strength.

A headrest designed solely to limit the rearward movement of a Driver's head in a collision situation must be fitted. The position of the headrest shall be such that the helmet must contact the headrest at a point no lower than half way up the back of the helmet with the Driver in the correct seated position. Fitment of a helmet pad to the headrest is permitted.

The Driver must be able to see over the top of the steering wheel when seated in his normal position in the kart. The Driver's legs must occupy the front half of the kart. It is required that the reinforcement of the seat mounting points on the seat body with metal spacers be at least 1.5mm thick and 60mm minimum diameter with bolt holes no bigger than 10mm.

A4: Floor Tray

There must be a floor, made from rigid material, which extends from the seat to the front of the kart. It must be edged on each side by a tube or rim to prevent the Driver's feet sliding off the floor. It must not exceed the width of the bodywork including wings and end plates. If perforated, the holes must be of less than 10mm diameter.

250cc INTERNATIONAL

A5: Bodywork

HEIGHT:

The maximum height of any part of the kart shall not exceed 710mm from the ground except for a structure solely designed as a head restraint with no possible positive aerodynamic effect; save that wings, including any end plates, may be not more than 1000mm above ground level.

BODYWORK:

The bodywork is made up of all parts of the kart that are in contact with air, and shall include fairings, bubble, side pods, floor tray and aerodynamic aids or wings. Bodywork does not include the air box, fuel tank, seat and number plates, and mechanical parts defined elsewhere. The bodywork must be structurally sound and finished without any sharp edges that could cause injury to a Competitor. Air vents, ducts or passages formed in bodywork or as separate elements to aid cooling or supply airflow to components shall be arranged to have soft and/or rolled radius to leading edges on scoops. There shall be no external protrusions beyond the vertical surface line of the side bodywork faces.

FAIRINGS:

The fairings are free forward of the steering wheel but must not cover the Driver rearward of the steering wheel when seated in the kart.

Fairings must not extend in width more than 50mm beyond the quadrilateral formed by the outer edges of the front and rear tyres. They must be completely hollow except for strengthening panels.

Fairings must be of safe and sound construction and must be securely fastened to the frame. They must be firmly fixed in position and not be adjustable by any means whilst the kart is in motion. The material is restricted to:

- Glass reinforced epoxy or polyester resin;
- Composite construction including Kevlar and carbon fibre substrate;
- Vacuum-formed ABS at least 2mm thick or comparable non-shatterable material.

Fairings must be easily removable for scrutineering.

BUBBLE:

Perspex, plexiglass or fibreglass bubbles, of at least 1.2mm thickness may be fitted, but may not extend more than 75mm above the top of the steering wheel.

AREOFOILS/WINGS:

Must be mounted on the frame of the kart with a minimum of four supports of at least 13mm x 2mm tubing, or equivalent. They must be firmly fixed in position, and not be adjustable by any means, whilst the kart is in motion and must not be used as containers. The leading edge of any aerofoil must have a minimum radius of 5mm. Allowable materials for construction of aerofoils:

- Glass reinforced epoxy or polyester resin;
- Composite construction including Kevlar and carbon fibre substrate;;

It is mandatory to run a rear aerofoil/wing in the 250cc classes at all events.

MIRRORS:

Mirrors are optional.

A6: Brakes

Brakes must be foot operated and provide efficient braking to all four wheels. Where there is free play at the ends of the axle keys a hose clamp or other positive mechanical method of key retention is required. All exposed brake pad mounting bolts must be drilled and lock wired.

Dual circuit brakes on all four wheels are compulsory for all Gearbox class karts.

Brake rods must be of at least 6mm diameter, of solid steel. It is recommended that a secondary actuating method be securely fitted which shall operate the brake master cylinder/s in the event of the detachment or failure of the primary link component/s fitted between the pedal assembly and the brake master cylinder/s assembly.

Brake hoses, lines and fittings are to be of suitable pressure line materials designed specifically for hydraulic use. Brake lines shall be connected to components and fittings using male type supporting connections. The use of female type compression olive fittings alone is prohibited.

Brake calliper and master cylinder mounting bolts must be of high-tensile steel, and must be drilled and lock wired and where applicable be secured by self-locking nuts.

The use of carbon fibre disc rotors in Superkart racing is prohibited.

Brakes must be fitted to both front wheels, as well as to the rear wheels. Karts shall be equipped with a double circuit braking system so arranged that the pedal normally operates on the four road wheels and in the event of leakage at any point in the braking system, the pedal shall still control two wheels on the same axle.

A7: Wheels & Tyres

WHEELS:

All road wheels must have a total of six bead retaining bolts, i.e. three inside and three outside per wheel. These bolts must be evenly spaced around the circumference of the wheel and incorporate an O-ring to prevent leakage. Penalty for non-compliance: exclusion from the meeting.

TYRES:

Tyres shall be pneumatic, with a maximum outside diameter of 350mm. Retreaded or remoulded tyres are prohibited.

All wheels shall revolve on ball or roller type bearings, either as separately mounted wheels or on a rotating axle shaft. Cast iron and plastic wheels are forbidden. Wheels must be secured to their axles by either high tensile bolts or self-locking nuts. Axles must be steel.

The attachment of wheels to hubs must be by stud and self-locking nut fixing with at least 3 threads through the nylock, or single hub-nut and locking clip.

The use of hand-grooved tyres is prohibited.

The use of any form of tyre treatment is prohibited.

The number of tyres that may be used during any race meeting, is unrestricted.

It is compulsory for tyres used to be:

- Fitted to 6" diameter rims;
- Selected from the 6" tyres homologated by the FIA/CIK;
- Comply with the FIA/CIK regulations for Superkart (Group I - Division 1 and 2);
- Bear the "CIK" or "CIK/SK ICE" marking.

250cc INTERNATIONAL

Recommended Tyres	6" Dunlop DEM-DAU
	6" Hoosier R60/R60A/R60B

All 4 tyres fitted must be of the same brand and compound.

VALVE CAPS:

All tyre/wheels must use metal valve caps at all times. These caps used must be sufficient design to maintain tyre integrity in case of valve mechanism failure.

A8: Weight

The minimum combined kart/Driver weight for Superkart events shall be as follows:

250cc International: 218kg

All ballast must be securely fastened to the chassis or seat only. Lead weights cannot be in blocks larger than 5kg, each of which must be secured by 8mm bolts and 60mm washer.

The wearing of weight belts by the Driver is forbidden.

Any kart/Driver combination found to not meet the minimum weight shall be excluded from that part of the meeting in which the irregularity was detected. The owner and Driver shall be reported to the Stewards of the meeting for further penalty.

A9: Numbers

The number plate must be at least 200mm H x 200mm W. The relevant colours shall be:

250cc International: PLATE: Yellow NUMBER: Black

The numbers must be at least 170mm high and of 20mm stroke width. They shall be fitted to both front and rear of each kart. The front number shall be attached to the bubble or Nassau Panel. A third number plate shall be mounted on the side of the kart facing the timekeepers/lap scorers. The side number shall be positioned in the area:

- No more than 500mm in front of the centreline of the rear axle;
- With the lower edge of the numbers above a horizontal line drawn through the top edge of the rear tyre;
- The plate itself must be vertical and parallel to the centreline of the kart.

National Superkart Champions in each class as well as second and third placegetters are allocated the use of the number 1, 2 and 3 respectively as their racing number in that class for the period during which they are National Champions or placegetters. The colours must be as specified for that class.

A10: Cooling

All karts, if not fitted with a sealed cooling system, must be fitted with a catch tank of at least 500ml capacity to retain radiator overflow. Glycol-based coolants are prohibited.

Radiators must not be placed in front of the pedals or behind the rear bumper, however may be mounted atop of the rear bumper. Radiator caps shall be lock wired or pinned to prevent removal during racing.

A11: Fuel

Only fuels as defined by Technical Regulations - Fuel* shall be used, with the Superkart Gearbox Classes permitted to use the following fuel types :

- (i) "Pump Fuel" as defined by regulations F2.1 and F2.2
- (ii) "Racing Fuel" as defined by regulation F3
- (iii) Approved Fuel as defined by (a) and (b) below :

- (a) VP Racing Fuels CR99
- (b) PowerPlus 100+

**see Section 'F' at the very end of these regulations.*

It is permitted to add to the fuel commercially-available two-stroke oil lubricants that produce two-stroke fuel within the provisions of Tech Regs-Fuel. Additives not described as such upon proprietary fixed labelling are specifically prohibited, and any performance boosters incorporated in the two-stroke oil is deemed to be illegal under these rules.

A11.1: Fuel Tanks

Each fuel tank shall be firmly fixed to the chassis or the floor tray and not by any temporary system of attachment. It shall be constructed in such a way that neither it nor any fuel pipes, which shall be flexible, present any danger of leakage during the competition. The tank shall be fitted with a male connector to accept the fuel line, which shall be wired or clamped.

In each Superkart it is mandatory to install the fuel tank between each main tube of the chassis-frame, ahead of the seat and behind the rotation axis of each front wheel, in accordance with the following conditions:

- Fuel shall be delivered from the fuel tank to the fuel pump only by gravity and/or by atmospheric pressure.
- The tank may be constructed of any leakproof material. Each steel tank shall be manufactured from sheet minimum 0.7mm thick.
- Flame-retardant material is recommended. Maximum capacity of any fuel tank: 18 litres.
- Taps are optional. If fitted, they must be within easy reach of the Driver when seated in the kart.
- Each tank and each fitting shall not project beneath the floor pan.

A12: Transmission

Front wheel drive systems are forbidden.

Clutches are compulsory.

All gearbox drain plugs must be lock wired and all other drain, indent plunger caps and filler caps must be wired.

Engine sprocket and chain guards are compulsory and must effectively cover the engine sprocket and the axle sprocket down to the centre line of the axle sprocket. All chain guards must be securely attached to the kart at both ends.

All automatic methods of chain oiling and greasing are prohibited.

Gearboxes must be fitted with a breather pipe which discharges into an overflow bottle of at least 250ml capacity. Any discharge must be contained, and not fall on to the track.

Where the Driver and other persons or their clothing may come into contact with a moving component that forms part of the engine or transmission, a guard must be fitted to prevent such contact occurring.

A13: Engine

The classes shall be open to karts fitted with two-stroke engines.

Permitted engines are identified as being the OEM engine cases that carry an indented, stamped manufacturers or owner's identification code or Number and are subject to one of the following:

- being normally fitted to production motorcycles;
- homologated for use in karting by the FIA or CIK;
- Approved for use by the Australian Motor Race Commission.

Modifications are allowed, subject to the general specifications complying with the Superkart Formula.

In addition to the Regulation above:

- two cylinders maximum per machine
- two single-cylinder 125cc Gearbox engines are permitted
- Rotax 256 engines may be fitted with approved replacement 'SAFE' engine cases and parts.

A 5% tolerance on swept volume, calculated on the designated class capacity, shall apply to engines with cast iron bore cylinders. Engines manufactured with plated cylinders, e.g. Nikasil, chrome etc. and shall have a bore diameter not exceeding the original standard specifications for that make/brand, type and model engine.

Re-building and re-plating of damaged plated cylinders is permitted, provided that the original specifications are adhered to. Plated bore cylinders are not permitted to be re-sleeved to take advantage of this tolerance.

Supercharging / Turbocharging of engines is forbidden.

The exhaust system shall discharge towards the rear and away from the Driver and the exhaust outlet shall not exceed 500mm in height. The exit must not include sharp edges. The outlet of the muffler must be within the perimeter of the kart when viewed from above. The complete exhaust system must be securely fastened to the kart so as to ensure that it cannot fall should a mounting fail.

All karts must be fitted with mufflers. The maximum emitted sound is 95dB (A), measured at 30m from the track edge. The Driver, seated normally, must be protected from all contact with the exhaust system. It is recommended that all exhaust springs be tie wired to prevent falling on the track.



250cc NATIONAL

250cc NATIONAL

B1: Chassis

IDENTIFICATION:

Each chassis must be marked with a unique identification number/code in a visible position on a non-removable main rail or member. This number/code shall be by permanent incident or impression of numerical and/or alpha characters and shall be recorded in the kart's log book.

DIMENSIONS:

- The wheelbase must be at least 1000mm and not more than 1270mm.
- The track must be at least two-thirds of the wheelbase.
- The overall length must not exceed 2400mm.

CONSTRUCTION:

The frame must be of all metal construction.

TRANSPONDER:

Timing transmitters when fitted shall be located with the whole of the unit and mounting behind the front axle centreline in the straight ahead position with nothing metallic between the transponder and the ground.

BUMPERS:

Each kart must be fitted with bumpers front and rear. No component of the kart (other than the front fairing) may extend past either the front or rear bumpers, but may be mounted on or attached to the bumpers.

Front bumpers must be rigid, positioned forward of the feet and mounted at the line of or forward of the front chassis rail. They may consist of single or parallel tubes, and attached fixings, tabs, brackets and supports for the front fairing are allowed.

The bumper must be; a minimum diameter of 16 mm Steel tubing and have a minimum wall thickness of 1.5 mm, and be mounted horizontally at a line perpendicular to the centre line of the kart and at a height no less than half way up the driver's feet when seated. Front bumpers shall have a minimum of four mountings to the main chassis placed with two either side of the front central point extremities and two at the side return ends. Front Bumper height shall not be adjustable in any way while the vehicle is in motion. Any support arms and struts shall be tubular with minimum 15mm radius edges, and have no sharp or angular points at the extremities.

Each rear bumper shall be composed of at least one bar with a minimum diameter of 18mm and a minimum wall thickness of 1.5mm in the area between the chassis main rails; the lowest bar shall be located at a height to ground not exceeding 170mm. The rear bumper unit must be fixed to the chassis frame in at least two points.

Rear wheel protection is mandatory. Minimum width shall be 1,080mm The rear bumper maximum width shall not exceed the dimension between the outer flanges of the rear wheels regardless of the rear track setting.

Rear bumper overhang shall not exceed 400mm behind the rear axle centreline. The outer ends must be located behind the rear wheels, and:

- Any support struts or bars shall not have sharp or angular parts at the extremities;
- The outer ends shall comprise a minimum 120° tubular bending with a minimum radius of 50mm that returns back to the mounting leaving no exposed tube end/s;
- May be fitted in an angled, horizontal or vertical plane;
- The rear wheel protection bar/s shall be located within an area between 80mm and 260mm height to the ground.

Side Bumpers must be fitted to both outside faces of the chassis-frame main rail to cover the area behind the front wheel and forward of the rear wheel and must consist in at least 2 steel elements:

- a steel tube upper bar mounted above a steel tube lower bar,- all with a minimum diameter of 16mm Steel tubing and have a minimum wall thickness of 1.5mm,
- both bars must be connected, with a minimum of at least one additional intermediate support tube, and welded together, and presenting a vertical flat face.

Minimum length of the bars parallel to ground: 500mm for the lower bar, 400mm for the upper bar.

Height of the lower bar: 50 +/-20mm from the ground.

Height of the upper bar: 200 +/-20mm from the ground.

The upper bar shall return on to and connect to the lower bar generally as follows: at the front the return end is to angle inwards to a point no less than 100mm from the bottom bar outer face line, and at the rear the return end may be angled as per the front, or return to the bottom bar at the face line no less than 120mm forward of the rear wheel tread face.

Side Bumpers shall have at least one intermediate support between upper and lower bars of the same spec material.

Each side bumper assembly must be attached to the chassis-frame main rail by 2 points minimum. These 2 attachments must be parallel to the ground and they must be 500mm minimum apart.

Side Bumpers may be formed to replicate side pod shapes that taper inward behind the front wheels, and shall cover a minimum of two-thirds of the tread width of the dry(slick) rear tyres and front tyres while positioned at the straight ahead position.

Side bumpers within side pods of non-quadrilateral outer face shape including 'wedge' styles must conform to the preceding, save that any portion of the upper bar unable to be placed parallel to ground and below 200mm +/- 20mm from the ground must replicate that side pod outer face upper extremity shape.

DIMENSION	LETTER	VALUE
CHASSIS MOUNTS	A	500mm (min)
GROUND CLEARANCE	B	50mm ± 20mm
TUBE DIAMETER	C	16mm x 1.5mm (min)
LOWER SECTION PARALLEL TO GROUND	D	500mm (min)
UPPER SECTION PARALLEL TO GROUND	E	400mm (min)
HEIGHT OF UPPER BAR	F	200mm ± 20mm
UPPER BAR RETURN POINT	G	100mm (min)
UPPER BAR REAR RETURN POINT	H	120mm (max)
CLEARANCE TO FRONT WHEEL	I	150mm (max)

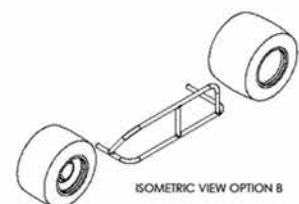
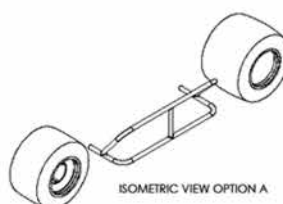
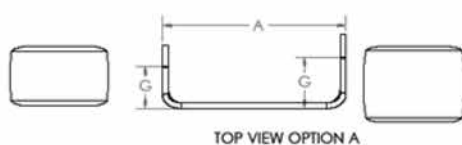
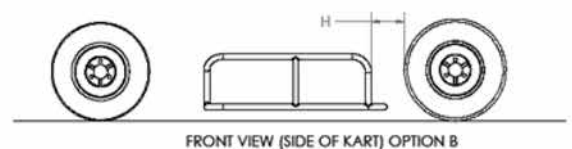
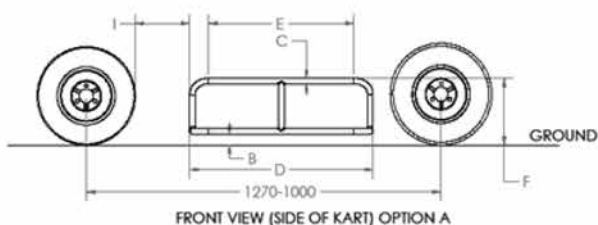

SUSPENSION:

Any suspension device is prohibited.

250cc NATIONAL

B2: Controls

PEDALS:

Whatever the position of the pedals, they must not protrude forward of the chassis, including the bumper.

THROTTLE:

The throttle must be operated by a pedal equipped with a return spring.

The carburettor must incorporate a throttle return spring.

****Hand controls:**

For the operation of the throttle and brakes are subject to the approval of the MA Technical Department. Such controls shall be identified in the kart's Log Book. These controls shall only be permitted for use by Competitors with individual disabilities.

STEERING:

Steering must be effected by the operation of a full wheel or aircraft type wheel, which has a full metal frame.

Straight handle-bars are forbidden.

Detachable steering wheels are permitted provided that they meet all other requirements and are approved by the scrutineers of the meeting.

Steering stops may be fitted.

The steering must be direct acting through a steel steering shaft of at least 16mm diameter if solid; or 19mm diameter if tubular having a minimum wall thickness of 2mm for steering wheel attachment.

The steering wheel boss must be manufactured of metal. Solid material, e.g., nylon or hardwood, must be inserted through the steering column where the steering boss bolt passes through, in order to prevent the column collapsing when the bolt is tightened. The steering shaft shall have a failsafe system to prevent it being pulled from the lower bush or bearing. All steering linkage assembly bolts and nuts must be cottered, lock wired, or fitted with self-locking nuts (including king pin bolts).

The tie rods must be of at least 8mm OD steel rod, 10mm OD by 2mm steel tube, or 10mm OD aluminium rod, or 12mm OD by 2.6mm aluminium alloy tube. In all female components of all steering rod ends and steering tie rods, there must be an inspection hole of 1mm diameter drilled 8mm from the open end. When assembled the inspection hole must be covered by thread.

All bolts must be of at least 6mm diameter, of high tensile steel with a shear strength of not less than 6KN. All tie rods must have "Rose" joints or similar aircraft type universal joints.

CLUTCH AND GEAR SHIFT LEVERS:

Gear and clutch, levers or paddles shall be positioned behind the steering wheel when viewed from the Drivers position, so that they are within fingertip reach from the steering wheel. Gear and Clutch control by steering wheel mounted activation buttons of electric, electronic, servo, pneumatic or pressure line systems is permitted. Further, foot operated clutch pedal situated left of the centre mounted brake pedal is permitted.

SWITCHES:

Each Superkart shall be equipped with an isolation (master) switch which effectively isolates all electrical circuits from the battery and stops the engine. Switches shall be capable of being operated by the seated Driver and from outside the automobile. These switches shall be clearly marked by a symbol showing a red spark in a white-edged blue triangle shown on the bodywork outer surface.



Control switches for electrically powered devices and accessories must be located forward of the Drivers elbow in the normal seated driving position, and be accessible to trackside officials with the Driver seated. The allowable mounting areas are confined to; an area beside the forward part of the seat; the Nassau panel/ bubble area; or on the steering wheel. Switches may be toggle, slide or push-pull type, and shall be individually identified as to on/off position and function. Grouped switches shall be arranged so that all are 'off' and 'on' in the same direction or position.

RAIN LIGHTS:

Rain lights are mandatory for Superkarts. They shall be a unit approved by the FIA or CIK. Tail lights must be powered by a sealed battery and controlled from the cockpit by a waterproof switch. The centre point of the light face must be in an area located 350-600mm from the ground and not more than 100mm either side of the centre line of the kart.

It must be in working condition throughout the meeting. It must be switched on when the race is declared "wet" by the Clerk of the Course or when wet weather tyres are fitted.

B3: Seat

The seat must be so designed that the Driver is well located to resist movement towards the side or front when cornering or braking. It must be firmly attached to the frame by at least four mountings of adequate strength.

A headrest designed solely to limit the rearward movement of a Driver's head in a collision situation must be fitted. The position of the headrest shall be such that the helmet must contact the headrest at a point no lower than half way up the back of the helmet with the Driver in the correct seated position. Fitment of a helmet pad to the headrest is permitted.

The Driver must be able to see over the top of the steering wheel when seated in his normal position in the kart. The Driver's legs must occupy the front half of the kart. It is required that the reinforcement of the seat mounting points on the seat body with metal spacers be at least 1.5mm thick and 60mm minimum diameter with bolt holes no bigger than 10mm.

B4: Floor Tray

There must be a floor, made from rigid material, which extends from the seat to the front of the kart. It must be edged on each side by a tube or rim to prevent the Driver's feet sliding off the floor. It must not exceed the width of the bodywork including wings and end plates. If perforated, the holes must be of less than 10mm diameter.

250cc NATIONAL

B5: Bodywork

HEIGHT:

The maximum height of any part of the kart shall not exceed 710mm from the ground except for a structure solely designed as a head restraint with no possible positive aerodynamic effect; save that wings, including any end plates, may be not more than 1000mm above ground level.

BODYWORK:

The bodywork is made up of all parts of the kart that are in contact with air, and shall include fairings, bubble, side pods, floor tray and aerodynamic aids or wings. Bodywork does not include the air box, fuel tank, seat and number plates, and mechanical parts defined elsewhere. The bodywork must be structurally sound and finished without any sharp edges that could cause injury to a Competitor. Air vents, ducts or passages formed in bodywork or as separate elements to aid cooling or supply airflow to components shall be arranged to have soft and/or rolled radius to leading edges on scoops. There shall be no external protrusions beyond the vertical surface line of the side bodywork faces.

FAIRINGS:

The fairings are free forward of the steering wheel but must not cover the Driver rearward of the steering wheel when seated in the kart.

Fairings must not extend in width more than 50mm beyond the quadrilateral formed by the outer edges of the front and rear tyres. They must be completely hollow except for strengthening panels.

Fairings must be of safe and sound construction and must be securely fastened to the frame. They must be firmly fixed in position and not be adjustable by any means whilst the kart is in motion. The material is restricted to:

- Glass reinforced epoxy or polyester resin;
- Composite construction including Kevlar and carbon fibre substrate;
- Vacuum-formed ABS at least 2mm thick or comparable non-shatterable material.

Fairings must be easily removable for scrutineering.

BUBBLE:

Perspex, plexiglass or fibreglass bubbles, of at least 1.2mm thickness may be fitted, but may not extend more than 75mm above the top of the steering wheel.

AREOFOILS/WINGS:

Must be mounted on the frame of the kart with a minimum of four supports of at least 13mm x 2mm tubing, or equivalent. They must be firmly fixed in position, and not be adjustable by any means, whilst the kart is in motion and must not be used as containers. The leading edge of any aerofoil must have a minimum radius of 5mm. Allowable materials for construction of aerofoils:

- Glass reinforced epoxy or polyester resin;
- Composite construction including Kevlar and carbon fibre substrate;;

It is mandatory to run a rear aerofoil/wing in the 250cc classes at all events.

MIRRORS:

Mirrors are optional.

B6: Brakes

Brakes must be foot operated and provide efficient braking to all four wheels. Where there is free play at the ends of the axle keys a hose clamp or other positive mechanical method of key retention is required. All exposed brake pad mounting bolts must be drilled and lock wired.

Dual circuit brakes on all four wheels are compulsory for all Gearbox class karts.

Brake rods must be of at least 6mm diameter, of solid steel. It is recommended that a secondary actuating method be securely fitted which shall operate the brake master cylinder/s in the event of the detachment or failure of the primary link component/s fitted between the pedal assembly and the brake master cylinder/s assembly.

Brake hoses, lines and fittings are to be of suitable pressure line materials designed specifically for hydraulic use. Brake lines shall be connected to components and fittings using male type supporting connections. The use of female type compression olive fittings alone is prohibited.

Brake calliper and master cylinder mounting bolts must be of high-tensile steel, and must be drilled and lock wired and where applicable be secured by self-locking nuts.

The use of carbon fibre disc rotors in Superkart racing is prohibited.

Brakes must be fitted to both front wheels, as well as to the rear wheels. Karts shall be equipped with a double circuit braking system so arranged that the pedal normally operates on the four road wheels and in the event of leakage at any point in the braking system, the pedal shall still control two wheels on the same axle.

B7: Wheels & Tyres

WHEELS:

All road wheels must have a total of six bead retaining bolts, i.e. three inside and three outside per wheel. These bolts must be evenly spaced around the circumference of the wheel and incorporate an O-ring to prevent leakage. Penalty for non-compliance: exclusion from the meeting.

TYRES:

Tyres shall be pneumatic, with a maximum outside diameter of 350mm. Retreaded or remoulded tyres are prohibited.

All wheels shall revolve on ball or roller type bearings, either as separately mounted wheels or on a rotating axle shaft. Cast iron and plastic wheels are forbidden. Wheels must be secured to their axles by either high tensile bolts or self-locking nuts. Axles must be steel.

The attachment of wheels to hubs must be by stud and self-locking nut fixing with at least 3 threads through the nylock, or single hub-nut and locking clip.

The use of hand-grooved tyres is prohibited.

The use of any form of tyre treatment is prohibited.

The number of tyres that may be used during any race meeting, is unrestricted.

It is compulsory for tyres used to be:

- Fitted to 6" diameter rims;
- Selected from the 6" tyres homologated by the FIA/CIK;
- Comply with the FIA/CIK regulations for Superkart (Group I - Division 1 and 2);
- Bear the "CIK" or "CIK/SK ICE" marking.

250cc NATIONAL

Recommended Tyres	6" Dunlop DEM-DAU
	6" Hoosier R60/R60A/R60B

All 4 tyres fitted must be of the same brand and compound.

VALVE CAPS:

All tyre/wheels must use metal valve caps at all times. These caps used must be sufficient design to maintain tyre integrity in case of valve mechanism failure.

B8: Weight

The minimum combined kart/Driver weight for Superkart events shall be as follows:

250cc National: 208kg

All ballast must be securely fastened to the chassis or seat only. Lead weights cannot be in blocks larger than 5kg, each of which must be secured by 8mm bolts and 60mm washer.

The wearing of weight belts by the Driver is forbidden.

Any kart/Driver combination found to not meet the minimum weight shall be excluded from that part of the meeting in which the irregularity was detected. The owner and Driver shall be reported to the Stewards of the meeting for further penalty.

B9: Numbers

The number plate must be at least 200mm H x 200mm W. The relevant colours shall be:

250cc National: PLATE: White NUMBER: Black

The numbers must be at least 170mm high and of 20mm stroke width. They shall be fitted to both front and rear of each kart. The front number shall be attached to the bubble or Nassau Panel. A third number plate shall be mounted on the side of the kart facing the timekeepers/lap scorers. The side number shall be positioned in the area:

- No more than 500mm in front of the centreline of the rear axle;
- With the lower edge of the numbers above a horizontal line drawn through the top edge of the rear tyre;
- The plate itself must be vertical and parallel to the centreline of the kart.

National Superkart Champions in each class as well as second and third placegetters are allocated the use of the number 1, 2 and 3 respectively as their racing number in that class for the period during which they are National Champions or placegetters. The colours must be as specified for that class.

B10: Cooling

All karts, if not fitted with a sealed cooling system, must be fitted with a catch tank of at least 500ml capacity to retain radiator overflow. Glycol-based coolants are prohibited.

Radiators must not be placed in front of the pedals or behind the rear bumper, however may be mounted atop of the rear bumper. Radiator caps shall be lock wired or pinned to prevent removal during racing.

B11: Fuel

Only fuels as defined by Technical Regulations - Fuel* shall be used, with the Superkart Gearbox Classes permitted to use the following fuel types :

- (i) "Pump Fuel" as defined by regulations F2.1 and F2.2
- (ii) "Racing Fuel" as defined by regulation F3
- (iii) Approved Fuel as defined by (a) and (b) below :

- (a) VP Racing Fuels CR99
- (b) PowerPlus 100+

**see Section 'F' at the very end of these regulations.*

It is permitted to add to the fuel commercially-available two-stroke oil lubricants that produce two-stroke fuel within the provisions of Tech Regs-Fuel. Additives not described as such upon proprietary fixed labelling are specifically prohibited, and any performance boosters incorporated in the two-stroke oil is deemed to be illegal under these rules.

B11.1: Fuel Tanks

Each fuel tank shall be firmly fixed to the chassis or the floor tray and not by any temporary system of attachment. It shall be constructed in such a way that neither it nor any fuel pipes, which shall be flexible, present any danger of leakage during the competition. The tank shall be fitted with a male connector to accept the fuel line, which shall be wired or clamped.

In each Superkart it is mandatory to install the fuel tank between each main tube of the chassis-frame, ahead of the seat and behind the rotation axis of each front wheel, in accordance with the following conditions:

- Fuel shall be delivered from the fuel tank to the fuel pump only by gravity and/or by atmospheric pressure.
- The tank may be constructed of any leakproof material. Each steel tank shall be manufactured from sheet minimum 0.7mm thick.
- Flame-retardant material is recommended. Maximum capacity of any fuel tank: 18 litres.
- Taps are optional. If fitted, they must be within easy reach of the Driver when seated in the kart.
- Each tank and each fitting shall not project beneath the floor pan.

250cc NATIONAL

B12: Transmission

Front wheel drive systems are forbidden.

Clutches are compulsory.

All gearbox drain plugs must be lock wired and all other drain, indent plunger caps and filler caps must be wired.

Engine sprocket and chain guards are compulsory and must effectively cover the engine sprocket and the axle sprocket down to the centre line of the axle sprocket. All chain guards must be securely attached to the kart at both ends.

All automatic methods of chain oiling and greasing are prohibited.

Gearboxes must be fitted with a breather pipe which discharges into an overflow bottle of at least 250ml capacity. Any discharge must be contained, and not fall on to the track.

Where the Driver and other persons or their clothing may come into contact with a moving component that forms part of the engine or transmission, a guard must be fitted to prevent such contact occurring.

B13: Engine

The classes shall be open to karts fitted with two-stroke or four-stroke engines.

Permitted engines are identified as being the OEM engine cases that carry an indented, stamped manufacturers or owner's identification code or Number and are subject to one of the following:

- being normally fitted to production motorcycles;
- homologated for use in karting by the FIA or CIK;
- Approved for use by the Australian Motor Race Commission.

Modifications are allowed, subject to the general specifications complying with the Superkart Formula.

A 5% tolerance on swept volume, calculated on the designated class capacity, shall apply to engines with cast iron bore cylinders. Engines manufactured with plated cylinders, e.g. Nikasil, chrome etc. and shall have a bore diameter not exceeding the original standard specifications for that make/brand, type and model engine.

Re-building and re-plating of damaged plated cylinders is permitted, provided that the original specifications are adhered to. Plated bore cylinders are not permitted to be re-sleeved to take advantage of this tolerance.

Supercharging / Turbocharging of engines is forbidden.

The exhaust system shall discharge towards the rear and away from the Driver and the exhaust outlet shall not exceed 500mm in height. The exit must not include sharp edges. The outlet of the muffler must be within the perimeter of the kart when viewed from above. The complete exhaust system must be securely fastened to the kart so as to ensure that it cannot fall should a mounting fail.

All karts must be fitted with mufflers. The maximum emitted sound is 95dB (A), measured at 30m from the track edge. The Driver, seated normally, must be protected from all contact with the exhaust system. It is recommended that all exhaust springs be tie wired to prevent falling on the track.

250cc Two-Stroke:

250cc two-stroke single cylinder per machine.

450cc Four-Stroke:

450cc four-stroke single-cylinder per machine

Modifications to the engine are allowed, provided the following are not varied.

- (i) Stroke
- (ii) Bore (outside Maximum Limits)
- (iii) Connecting rod centre line (magnetic material only)
- (iv) Ignition must remain OEM
- (v) Gearbox must retain the same amount of gears as OEM manufactured for the specified model at time of manufacture. (Fuel pulse pump or electric fuel pump is permitted for carburetted engine).
- (vi) Number of carburettors or throttle bodies (one (1) only).
- (vii) Fuel injection is permitted but only if OEM; i.e., if fitted as standard to the original motor type, it is permitted to upgrade motors and fit injection, provided the latest version of that model has injection fitted OEM. All upgrade parts must come from the manufacturer's parts list.
- (viii) All systems of injection and/or spraying of products other than permitted fuel are forbidden. It is not permitted to have an electronic connection to the carburettor unless this was standard OEM.



125cc
OPEN

C1: Chassis

IDENTIFICATION:

Each chassis must be marked with a unique identification number/code in a visible position on a non-removable main rail or member. This number/code shall be by permanent incident or impression of numerical and/or alpha characters and shall be recorded in the kart's log book.

DIMENSIONS:

- The wheelbase must be at least 1000mm and not more than 1270mm.
- The track must be at least two-thirds of the wheelbase.
- The overall length must not exceed 2400mm.

CONSTRUCTION:

The frame must be of all metal construction.

TRANSPONDER:

Timing transmitters when fitted shall be located with the whole of the unit and mounting behind the front axle centreline in the straight ahead position with nothing metallic between the transponder and the ground.

BUMPERS:

Each kart must be fitted with bumpers front and rear. No component of the kart (other than the front fairing) may extend past either the front or rear bumpers, but may be mounted on or attached to the bumpers.

Front bumpers must be rigid, positioned forward of the feet and mounted at the line of or forward of the front chassis rail. They may consist of single or parallel tubes, and attached fixings, tabs, brackets and supports for the front fairing are allowed.

The bumper must be; a minimum diameter of 16 mm Steel tubing and have a minimum wall thickness of 1.5 mm, and be mounted horizontally at a line perpendicular to the centre line of the kart and at a height no less than half way up the driver's feet when seated. Front bumpers shall have a minimum of four mountings to the main chassis placed with two either side of the front central point extremities and two at the side return ends. Front Bumper height shall not be adjustable in any way while the vehicle is in motion. Any support arms and struts shall be tubular with minimum 15mm radius edges, and have no sharp or angular points at the extremities.

Each rear bumper shall be composed of at least one bar with a minimum diameter of 18mm and a minimum wall thickness of 1.5mm in the area between the chassis main rails; the lowest bar shall be located at a height to ground not exceeding 170mm. The rear bumper unit must be fixed to the chassis frame in at least two points.

Rear wheel protection is mandatory. Minimum width shall be 1,080mm The rear bumper maximum width shall not exceed the dimension between the outer flanges of the rear wheels regardless of the rear track setting.

Rear bumper overhang shall not exceed 400mm behind the rear axle centreline. The outer ends must be located behind the rear wheels, and:

- Any support struts or bars shall not have sharp or angular parts at the extremities;
- The outer ends shall comprise a minimum 120° tubular bending with a minimum radius of 50mm that returns back to the mounting leaving no exposed tube end/s;
- May be fitted in an angled, horizontal or vertical plane;
- The rear wheel protection bar/s shall be located within an area between 80mm and 260mm height to the ground.

Side Bumpers must be fitted to both outside faces of the chassis-frame main rail to cover the area behind the front wheel and forward of the rear wheel and must consist in at least 2 steel elements:

- a steel tube upper bar mounted above a steel tube lower bar,- all with a minimum diameter of 16mm Steel tubing and have a minimum wall thickness of 1.5mm,
- both bars must be connected, with a minimum of at least one additional intermediate support tube, and welded together, and presenting a vertical flat face.

Minimum length of the bars parallel to ground: 500mm for the lower bar, 400mm for the upper bar.

Height of the lower bar: 50 +/-20mm from the ground.

Height of the upper bar: 200 +/-20mm from the ground.

The upper bar shall return on to and connect to the lower bar generally as follows: at the front the return end is to angle inwards to a point no less than 100mm from the bottom bar outer face line, and at the rear the return end may be angled as per the front, or return to the bottom bar at the face line no less than 120mm forward of the rear wheel tread face.

Side Bumpers shall have at least one intermediate support between upper and lower bars of the same spec material.

Each side bumper assembly must be attached to the chassis-frame main rail by 2 points minimum. These 2 attachments must be parallel to the ground and they must be 500mm minimum apart.

Side Bumpers may be formed to replicate side pod shapes that taper inward behind the front wheels, and shall cover a minimum of two-thirds of the tread width of the dry(slick) rear tyres and front tyres while positioned at the straight ahead position.

Side bumpers within side pods of non-quadrilateral outer face shape including 'wedge' styles must conform to the preceding, save that any portion of the upper bar unable to be placed parallel to ground and below 200mm +/- 20mm from the ground must replicate that side pod outer face upper extremity shape.

DIMENSION	LETTER	VALUE
CHASSIS MOUNTS	A	500mm (min)
GROUND CLEARANCE	B	50mm ± 20mm
TUBE DIAMETER	C	16mm x 1.5mm (min)
LOWER SECTION PARALLEL TO GROUND	D	500mm (min)
UPPER SECTION PARALLEL TO GROUND	E	400mm (min)
HEIGHT OF UPPER BAR	F	200mm ± 20mm
UPPER BAR RETURN POINT	G	100mm (min)
UPPER BAR REAR RETURN POINT	H	120mm (max)
CLEARANCE TO FRONT WHEEL	I	150mm (max)

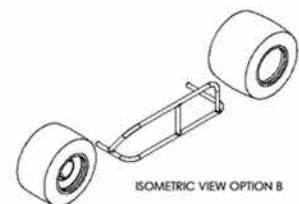
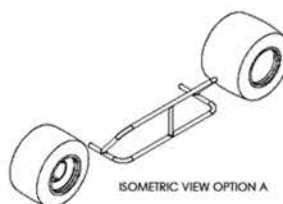
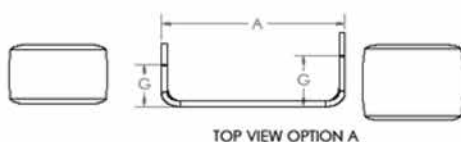
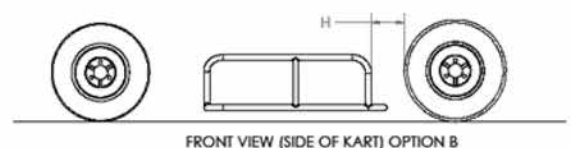
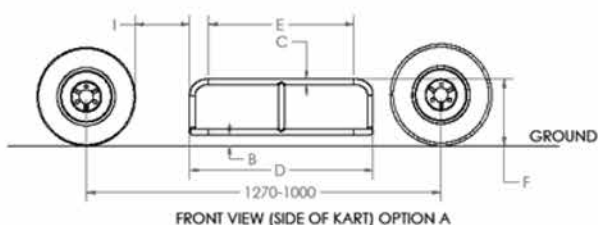

SUSPENSION:

Any suspension device is prohibited.

C2: Controls

PEDALS:

Whatever the position of the pedals, they must not protrude forward of the chassis, including the bumper.

THROTTLE:

The throttle must be operated by a pedal equipped with a return spring.

The carburettor must incorporate a throttle return spring.

****Hand controls:**

For the operation of the throttle and brakes are subject to the approval of the MA Technical Department. Such controls shall be identified in the kart's Log Book. These controls shall only be permitted for use by Competitors with individual disabilities.

STEERING:

Steering must be effected by the operation of a full wheel or aircraft type wheel, which has a full metal frame.

Straight handle-bars are forbidden.

Detachable steering wheels are permitted provided that they meet all other requirements and are approved by the scrutineers of the meeting.

Steering stops may be fitted.

The steering must be direct acting through a steel steering shaft of at least 16mm diameter if solid; or 19mm diameter if tubular having a minimum wall thickness of 2mm for steering wheel attachment.

The steering wheel boss must be manufactured of metal. Solid material, e.g., nylon or hardwood, must be inserted through the steering column where the steering boss bolt passes through, in order to prevent the column collapsing when the bolt is tightened. The steering shaft shall have a failsafe system to prevent it being pulled from the lower bush or bearing. All steering linkage assembly bolts and nuts must be cottered, lock wired, or fitted with self-locking nuts (including king pin bolts).

The tie rods must be of at least 8mm OD steel rod, 10mm OD by 2mm steel tube, or 10mm OD aluminium rod, or 12mm OD by 2.6mm aluminium alloy tube. In all female components of all steering rod ends and steering tie rods, there must be an inspection hole of 1mm diameter drilled 8mm from the open end. When assembled the inspection hole must be covered by thread.

All bolts must be of at least 6mm diameter, of high tensile steel with a shear strength of not less than 6KN. All tie rods must have "Rose" joints or similar aircraft type universal joints.

CLUTCH AND GEAR SHIFT LEVERS:

Gear and clutch, levers or paddles shall be positioned behind the steering wheel when viewed from the Drivers position, so that they are within fingertip reach from the steering wheel. Gear and Clutch control by steering wheel mounted activation buttons of electric, electronic, servo, pneumatic or pressure line systems is permitted. Further, foot operated clutch pedal situated left of the centre mounted brake pedal is permitted.

SWITCHES:

Each Superkart shall be equipped with an isolation (master) switch which effectively isolates all electrical circuits from the battery and stops the engine. Switches shall be capable of being operated by the seated Driver and from outside the automobile. These switches shall be clearly marked by a symbol showing a red spark in a white-edged blue triangle shown on the bodywork outer surface.



Control switches for electrically powered devices and accessories must be located forward of the Drivers elbow in the normal seated driving position, and be accessible to trackside officials with the Driver seated. The allowable mounting areas are confined to; an area beside the forward part of the seat; the Nassau panel/ bubble area; or on the steering wheel. Switches may be toggle, slide or push-pull type, and shall be individually identified as to on/off position and function. Grouped switches shall be arranged so that all are 'off' and 'on' in the same direction or position.

RAIN LIGHTS:

Rain lights are mandatory for Superkarts. They shall be a unit approved by the FIA or CIK. Tail lights must be powered by a sealed battery and controlled from the cockpit by a waterproof switch. The centre point of the light face must be in an area located 350-600mm from the ground and not more than 100mm either side of the centre line of the kart.

It must be in working condition throughout the meeting. It must be switched on when the race is declared "wet" by the Clerk of the Course or when wet weather tyres are fitted.

C3: Seat

The seat must be so designed that the Driver is well located to resist movement towards the side or front when cornering or braking. It must be firmly attached to the frame by at least four mountings of adequate strength.

A headrest designed solely to limit the rearward movement of a Driver's head in a collision situation is optional. If fitted the headrest shall be such that the helmet must contact the headrest at a point no lower than half way up the back of the helmet with the Driver in the correct seated position. Fitment of a helmet pad to the headrest is permitted.

The Driver must be able to see over the top of the steering wheel when seated in his normal position in the kart. The Driver's legs must occupy the front half of the kart. It is required that the reinforcement of the seat mounting points on the seat body with metal spacers be at least 1.5mm thick and 60mm minimum diameter with bolt holes no bigger than 10mm.

C4: Floor Tray

There must be a floor, made from rigid material, which extends from the seat to the front of the kart. It must be edged on each side by a tube or rim to prevent the Driver's feet sliding off the floor. It must not exceed the width of the bodywork including wings and end plates. If perforated, the holes must be of less than 10mm diameter.

C5: Bodywork

HEIGHT:

The maximum height of any part of the kart shall not exceed 710mm from the ground except for a structure solely designed as a head restraint with no possible positive aerodynamic effect; save that wings, including any end plates, may be not more than 1000mm above ground level.

BODYWORK:

The bodywork is made up of all parts of the kart that are in contact with air, and shall include fairings, bubble, side pods, floor tray and aerodynamic aids or wings. Bodywork does not include the air box, fuel tank, seat and number plates, and mechanical parts defined elsewhere. The bodywork must be structurally sound and finished without any sharp edges that could cause injury to a Competitor. Air vents, ducts or passages formed in bodywork or as separate elements to aid cooling or supply airflow to components shall be arranged to have soft and/or rolled radius to leading edges on scoops. There shall be no external protrusions beyond the vertical surface line of the side bodywork faces.

FAIRINGS:

The fairings are free forward of the steering wheel but must not cover the Driver rearward of the steering wheel when seated in the kart.

Fairings must not extend in width more than 50mm beyond the quadrilateral formed by the outer edges of the front and rear tyres. They must be completely hollow except for strengthening panels.

Fairings must be of safe and sound construction and must be securely fastened to the frame. They must be firmly fixed in position and not be adjustable by any means whilst the kart is in motion. The material is restricted to:

- Glass reinforced epoxy or polyester resin;
- Composite construction including Kevlar and carbon fibre substrate;
- Vacuum-formed ABS at least 2mm thick or comparable non-shatterable material.

Fairings must be easily removable for scrutineering.

BUBBLE:

Perspex, plexiglass or fibreglass bubbles, of at least 1.2mm thickness may be fitted, but may not extend more than 75mm above the top of the steering wheel.

AREOFOILS/WINGS:

On 125cc Gearbox karts, the use of a rear wing is optional, if fitted, they must:

Be mounted on the frame of the kart with supports of at least 13mm x 2mm tubing, or equivalent. They must be firmly fixed in position, and not be adjustable by any means, whilst the kart is in motion and must not be used as containers. The leading edge of any aerofoil must have a minimum radius of 5mm. Recommended materials for construction of aerofoils:

- Glass reinforced epoxy or polyester resin;
- Composite construction including Kevlar and carbon fibre substrate.

MIRRORS:

Mirrors are optional.

C6: Brakes

Brakes must be foot operated and provide efficient braking to all four wheels. Where there is free play at the ends of the axle keys a hose clamp or other positive mechanical method of key retention is required. All exposed brake pad mounting bolts must be drilled and lock wired.

Dual circuit brakes on all four wheels are compulsory for all Gearbox class karts.

Brake rods must be of at least 6mm diameter, of solid steel. It is recommended that a secondary actuating method be securely fitted which shall operate the brake master cylinder/s in the event of the detachment or failure of the primary link component/s fitted between the pedal assembly and the brake master cylinder/s assembly.

Brake hoses, lines and fittings are to be of suitable pressure line materials designed specifically for hydraulic use. Brake lines shall be connected to components and fittings using male type supporting connections. The use of female type compression olive fittings alone is prohibited.

Brake calliper and master cylinder mounting bolts must be of high-tensile steel, and must be drilled and lock wired and where applicable be secured by self-locking nuts.

The use of carbon fibre disc rotors in Superkart racing is prohibited.

Brakes must be fitted to both front wheels, as well as to the rear wheels. Karts shall be equipped with a double circuit braking system so arranged that the pedal normally operates on the four road wheels and in the event of leakage at any point in the braking system, the pedal shall still control two wheels on the same axle.

C7: Wheels & Tyres

WHEELS:

- Any 5" diameter wheels.
- Any 6" diameter wheels.
- All 4 wheels fitted must be of the same diameter.

TYRES:

- Any 5" or 6" tyres homologated by the FIA/CIK;
- Must bear the "CIK" or "CIK/SK ICE" marking.

Tyres shall be pneumatic, with a maximum outside diameter of 350mm. Retreaded or remoulded tyres are prohibited.

All wheels shall revolve on ball or roller type bearings, either as separately mounted wheels or on a rotating axle shaft. Cast iron and plastic wheels are forbidden. Wheels must be secured to their axles by either high tensile bolts or self-locking nuts. Axles must be steel.

The attachment of wheels to hubs must be by stud and self-locking nut fixing with at least 3 threads through the nylock , or single hub-nut and locking clip.

- The use of hand-grooved tyres is prohibited.
- The use of any form of tyre treatment is prohibited.

At every State and National Championship race meeting, the class shall be limited to the use of up to eight dry weather (slick) tyres (four front and four rear). Except for treaded tyres used on a damp or wet track, which is unrestricted.

Recommended Tyres	6" Dunlop DEM-DAU
	6" Hoosier R55 / R60A / R60B
	5" MG yellow
	5" Dunlop DGM / DGH

All 4 tyres fitted must be of the same brand and compound.

VALVE CAPS:

All tyre/wheels must use metal valve caps at all times. These caps used must be sufficient design to maintain tyre integrity in case of valve mechanism failure.

C8: Weight

The minimum combined kart/Driver weight for Superkart events shall be as follows:

125cc Open: 195kg

All ballast must be securely fastened to the chassis or seat only. Lead weights cannot be in blocks larger than 5kg, each of which must be secured by 8mm bolts and 60mm washer.

The wearing of weight belts by the Driver is forbidden.

Any kart/Driver combination found to not meet the minimum weight shall be excluded from that part of the meeting in which the irregularity was detected. The owner and Driver shall be reported to the Stewards of the meeting for further penalty.

C9: Numbers

The number plate must be at least 200mm H x 200mm W. The relevant colours shall be:

125cc Open: PLATE: Red NUMBER: White

The numbers must be at least 170mm high and of 20mm stroke width. They shall be fitted to both front and rear of each kart. The front number shall be attached to the bubble or Nassau Panel. A third number plate shall be mounted on the side of the kart facing the timekeepers/lap scorers. The side number shall be positioned in the area:

- No more than 500mm in front of the centreline of the rear axle;
- With the lower edge of the numbers above a horizontal line drawn through the top edge of the rear tyre;
- The plate itself must be vertical and parallel to the centreline of the kart.

National Superkart Champions in each class as well as second and third placegetters are allocated the use of the number 1, 2 and 3 respectively as their racing number in that class for the period during which they are National Champions or placegetters. The colours must be as specified for that class.

C10: Cooling

All karts, if not fitted with a sealed cooling system, must be fitted with a catch tank of at least 500ml capacity to retain radiator overflow. Glycol-based coolants are prohibited.

Radiators must not be placed in front of the pedals or behind the rear bumper, however may be mounted atop of the rear bumper. Radiator caps shall be lock wired or pinned to prevent removal during racing.

C11: Fuel

Only fuels as defined by Technical Regulations - Fuel* shall be used, with the Superkart Gearbox Classes permitted to use the following fuel types :

- (i) "Pump Fuel" as defined by regulations F2.1 and F2.2
- (ii) "Racing Fuel" as defined by regulation F3
- (iii) Approved Fuel as defined by (a) and (b) below :
 - (a) VP Racing Fuels CR99
 - (b) PowerPlus 100+

**see Section 'F' at the very end of these regulations.*

It is permitted to add to the fuel commercially-available two-stroke oil lubricants that produce two-stroke fuel within the provisions of Tech Regs-Fuel. Additives not described as such upon proprietary fixed labelling are specifically prohibited, and any performance boosters incorporated in the two-stroke oil is deemed to be illegal under these rules.

C11.1: Fuel Tanks

Each fuel tank shall be firmly fixed to the chassis or the floor tray and not by any temporary system of attachment. It shall be constructed in such a way that neither it nor any fuel pipes, which shall be flexible, present any danger of leakage during the competition. The tank shall be fitted with a male connector to accept the fuel line, which shall be wired or clamped.

In each Superkart it is mandatory to install the fuel tank between each main tube of the chassis-frame, ahead of the seat and behind the rotation axis of each front wheel, in accordance with the following conditions:

- Fuel shall be delivered from the fuel tank to the fuel pump only by gravity and/or by atmospheric pressure.
- The tank may be constructed of any leakproof material. Each steel tank shall be manufactured from sheet minimum 0.7mm thick.
- Flame-retardant material is recommended. Maximum capacity of any fuel tank: 18 litres.
- Taps are optional. If fitted, they must be within easy reach of the Driver when seated in the kart.
- Each tank and each fitting shall not project beneath the floor pan.

C12: Transmission

Front wheel drive systems are forbidden.

Clutches are compulsory.

All gearbox drain plugs must be lock wired and all other drain, indent plunger caps and filler caps must be wired.

Engine sprocket and chain guards are compulsory and must effectively cover the engine sprocket and the axle sprocket down to the centre line of the axle sprocket. All chain guards must be securely attached to the kart at both ends.

All automatic methods of chain oiling and greasing are prohibited.

Gearboxes must be fitted with a breather pipe which discharges into an overflow bottle of at least 250ml capacity. Any discharge must be contained, and not fall on to the track.

Where the Driver and other persons or their clothing may come into contact with a moving component that forms part of the engine or transmission, a guard must be fitted to prevent such contact occurring.

C13: Engine

The classes shall be open to karts fitted with two-stroke engines.

Permitted engines are identified as being the OEM engine cases that carry an indented, stamped manufacturers or owner's identification code or Number and are subject to one of the following:

- being normally fitted to production motorcycles;
- homologated for use in karting by the FIA or CIK;
- Approved for use by the Australian Motor Race Commission.

Modifications are allowed, subject to the general specifications complying with the Superkart Formula.

In addition to the Regulation above:

- Not more than two cylinders per kart.
- Not more than seven forward gears.

A 5% tolerance on swept volume, calculated on the designated class capacity, shall apply to engines with cast iron bore cylinders. Engines manufactured with plated cylinders, e.g. Nikasil, chrome etc. and shall have a bore diameter not exceeding the original standard specifications for that make/brand, type and model engine.

Re-building and re-plating of damaged plated cylinders is permitted, provided that the original specifications are adhered to. Plated bore cylinders are not permitted to be re-sleeved to take advantage of this tolerance.

Supercharging / Turbocharging of engines is forbidden.

The exhaust system shall discharge towards the rear and away from the Driver and the exhaust outlet shall not exceed 500mm in height. The exit must not include sharp edges. The outlet of the muffler must be within the perimeter of the kart when viewed from above. The complete exhaust system must be securely fastened to the kart so as to ensure that it cannot fall should a mounting fail.

All karts must be fitted with mufflers. The maximum emitted sound is 95dB (A), measured at 30m from the track edge. The Driver, seated normally, must be protected from all contact with the exhaust system. It is recommended that all exhaust springs be tie wired to prevent falling on the track.



125cc
STOCK HONDA

Preamble

The spirit and intent is such that any attempt to elaborate on these Stock Honda regulations in order to gain a competitive advantage violates the basic premise of the class. A modification or tuning practice which is not permitted by the present regulations is expressly forbidden. Compliance is at all times the competitor's responsibility.

D1: Chassis

IDENTIFICATION:

Each chassis must be marked with a unique identification number/code in a visible position on a non-removable main rail or member. This number/code shall be by permanent incident or impression of numerical and/or alpha characters and shall be recorded in the kart's log book.

The chassis shall be CIK homologated and which bears the manufacturer's CIK tag intact on the chassis. If the chassis is not currently CIK homologated, documented proof must be presented that the chassis was previously CIK homologated.

The main frame rails and cross members shall not be altered. Maximum wheel base 104cm.

Repairs to the chassis are allowed provided the chassis remains within its approved CIK dimensions.

In the case of a questionable chassis the manufacturer's signed and approved CIK homologation document will be the definitive authority.

TRANSPONDER:

Timing transmitters when fitted shall be located with the whole of the unit and mounting behind the front axle centreline in the straight ahead position with nothing metallic between the transponder and the ground.

BUMPERS:

Each kart must be fitted with bumpers front and rear. No component of the kart (other than the front fairing) may extend past either the front or rear bumpers, but may be mounted on or attached to the bumpers.

Each rear bumper shall be composed of at least one bar with a minimum diameter of 18mm and a minimum wall thickness of 1.5mm in the area between the chassis main rails; the lowest bar shall be located at a height to ground not exceeding 170mm. The rear bumper unit must be fixed to the chassis frame in at least two points.

Rear wheel protection is mandatory. Minimum width shall be 1,080mm. The rear bumper maximum width shall not exceed the dimension between the outer flanges of the rear wheels regardless of the rear track setting.

Rear bumper overhang shall not exceed 400mm behind the rear axle centreline. The outer ends must be located behind the rear wheels, and:

- Any support struts or bars shall not have sharp or angular parts at the extremities;
- The outer ends shall comprise a minimum 120° tubular bending with a minimum radius of 50mm that returns back to the mounting leaving no exposed tube end/s;
- May be fitted in an angled, horizontal or vertical plane;
- The rear wheel protection bar/s shall be located within an area between 80mm and 260mm height to ground.

Alternatively, CIK-approved rear bumpers are also allowed

SUSPENSION:

Any suspension device is prohibited.

D2: Controls

PEDALS:

Whatever the position of the pedals, they must not protrude forward of the chassis, including the bumper.

THROTTLE:

The throttle must be operated by a pedal equipped with a return spring.

The carburettor must incorporate a throttle return spring.

****Hand controls:**

For the operation of the throttle and brakes are subject to the approval of the MA Technical Department. Such controls shall be identified in the kart's Log Book. These controls shall only be permitted for use by Competitors with individual disabilities.

STEERING:

Steering must be effected by the operation of a full wheel or aircraft type wheel, which has a full metal frame.

Straight handle-bars are forbidden.

Detachable steering wheels are permitted provided that they meet all other requirements and are approved by the scrutineers of the meeting.

Steering stops may be fitted.

The steering must be direct acting through a steel steering shaft of at least 16mm diameter if solid; or 19mm diameter if tubular having a minimum wall thickness of 2mm for steering wheel attachment.

The steering wheel boss must be manufactured of metal. Solid material, e.g., nylon or hardwood, must be inserted through the steering column where the steering boss bolt passes through, in order to prevent the column collapsing when the bolt is tightened. The steering shaft shall have a failsafe system to prevent it being pulled from the lower bush or bearing. All steering linkage assembly bolts and nuts must be cottered, lock wired, or fitted with self-locking nuts (including king pin bolts).

The tie rods must be of at least 8mm OD steel rod, 10mm OD by 2mm steel tube, or 10mm OD aluminium rod, or 12mm OD by 2.6mm aluminium alloy tube. In all female components of all steering rod ends and steering tie rods, there must be an inspection hole of 1mm diameter drilled 8mm from the open end. When assembled the inspection hole must be covered by thread.

All bolts must be of at least 6mm diameter, of high tensile steel with a shear strength of not less than 6KN. All tie rods must have "Rose" joints or similar aircraft type universal joints.

CLUTCH AND GEAR SHIFT LEVERS:

Gear and clutch, levers or paddles shall be positioned behind the steering wheel when viewed from the Drivers position, so that they are within fingertip reach from the steering wheel. Gear and Clutch control by steering wheel mounted activation buttons of electric, electronic, servo, pneumatic or pressure line systems is permitted. Further, foot operated clutch pedal situated left of the centre mounted brake pedal is permitted.

125cc STOCK HONDA

SWITCHES:

Each Superkart shall be equipped with an isolation (master) switch which effectively isolates all electrical circuits from the battery and stops the engine. Switches shall be capable of being operated by the seated Driver and from outside the automobile. These switches shall be clearly marked by a symbol showing a red spark in a white-edged blue triangle shown on the bodywork outer surface.



Control switches for electrically powered devices and accessories must be located forward of the Drivers elbow in the normal seated driving position, and be accessible to trackside officials with the Driver seated. The allowable mounting areas are confined to; an area beside the forward part of the seat; the Nassau panel/ bubble area; or on the steering wheel. Switches may be toggle, slide or push-pull type, and shall be individually identified as to on/off position and function. Grouped switches shall be arranged so that all are 'off' and 'on' in the same direction or position.

RAIN LIGHTS:

Rain lights are mandatory for Superkarts. They shall be a unit approved by the FIA or CIK. Tail lights must be powered by a sealed battery and controlled from the cockpit by a waterproof switch. The centre point of the light face must be in an area located 350-600mm from the ground and not more than 100mm either side of the centre line of the kart.

It must be in working condition throughout the meeting. It must be switched on when the race is declared "wet" by the Clerk of the Course or when wet weather tyres are fitted.

D3: Seat

Laydown-style seats are not allowed.

For CIK sprint-style seats, the seat back and seat bottom shall remain unaltered to original manufacture. Seat bottom may be repaired as required from road wear. No point of the seat back shall extend beyond the rear axle as per Figure D and the highest point of the seat back shall measure at least 360mm minimum off the ground measured in a vertical plane. It is required that the reinforcement of the seat mounting points on the seat body with metal spacers be at least 1.5mm thick and 60mm minimum diameter with a center hole no bigger than 10mm.

For Superkart-style seats, they may incorporate a headrest which is "as one" with the seat. The headrest shall not be detachable or adjustable in any form. Seat bottom may be repaired as required from road wear. No point of the seat back shall extend beyond the rear axle including any part of its head rest as per Figure A. It is required that the reinforcement of the seat mounting points on the seat body with metal spacers be at least 1.5mm thick and 60mm minimum diameter with a center hole no bigger than 10mm.

No part of the seat or headrest may extend beyond the vertical plane rearward of the axle.

Vertical plane refers to 90 degrees from level ground

NOTE: It is recommended the seat is positioned so there is enough allowance for the scrutineer to determine all parts of the seat is forward of the rear axle. Any uncertainty in this determination will be deemed non-compliant.

Figure A

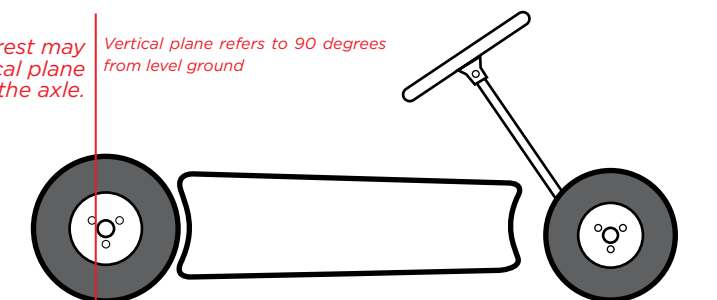

D4: Floor Tray

There must be a floor, made from rigid material, which extends from the seat to the front of the kart. It must be edged on each side by a tube or rim to prevent the Driver's feet sliding off the floor. It must not exceed the width of the bodywork including wings and end plates. If perforated, the holes must be of less than 10mm diameter.

D5: Bodywork

CIK sprint kart-style plastic nose cone, Nassau panel and side pods shall remain unaltered other than necessary for installation of radiator and mounting the side pods.

CIK plastic nose and Nassau panel may be replaced for fibreglass Superkart styled bodywork. Fibreglass bodywork, excluding mirrors, forward of the vertical plane drawn through the centre line of the front wheels in their straight ahead position must fall within the area of the template described in Figure B.

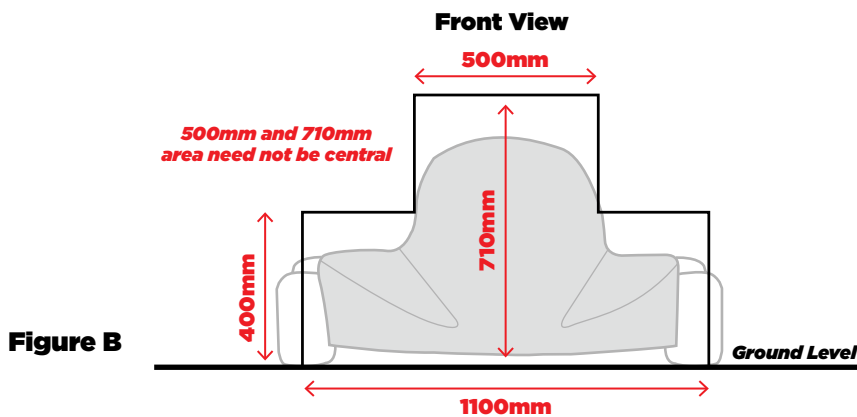

No bodywork rearward of this vertical plane shall extend further than 300mm rearward of that plane; be more than 710mm above the ground, be closer than 300mm to the ground, nor wider than 500mm as shown by the template described in Figure C.

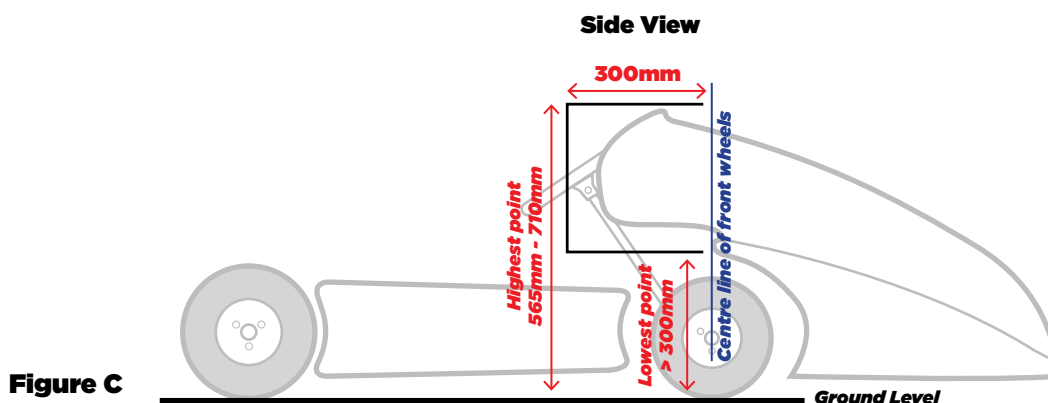

D6: Brakes

The kart shall have a single brake pedal that operates four-wheel braking using two separate braking circuits that governs the front and rear braking independently.

A brake calliper shall be fitted for each of the front axles as well as for the rear axle.

In the event of leakage at any point in the braking system, the pedal shall still operate braking to either the rear or the front axles.

D7: Wheels & Tyres

WHEELS:

5" diameter wheels.

TYRES:

Any 5" or 6" tyres homologated by the FIA/CIK;
Must bear the "CIK" or "CIK/SK ICE" marking.

A maximum of three individual front and three individual rear tyres (six tyres total) are allowed per race meeting, marked by the Chief Scrutineer or his nominee prior to qualifying.

Tyres shall be pneumatic, with or without tubes.
Retreaded or remoulded tyres are prohibited.

All wheels shall revolve on ball or roller type bearings, either as separately mounted wheels or on a rotating axle shaft. Cast iron and plastic wheels are forbidden. Wheels must be secured to their axles by either high tensile bolts or self-locking nuts. Axles must be steel.

The attachment of wheels to hubs must be by stud and self-locking nut fixing with at least 3 threads through the nylock, or single hub-nut and locking clip.

The use of hand-grooved tyres is prohibited.
The use of any form of tyre treatment is prohibited.

Recommended Dry Tyres	5" MG yellow
	5" Dunlop DGM / DGH
Wet Tyres	Free (<i>must be fitted to 5" rims</i>)

All 4 tyres fitted must be of the same brand and compound.

VALVE CAPS:

All tyre/wheels must use metal valve caps at all times. These caps used must be sufficient design to maintain tyre integrity in case of valve mechanism failure.

D8: Weight

The minimum combined kart/Driver weight for Superkart events shall be as follows:

125cc Stock Honda: 180kg

All ballast must be securely fastened to the chassis or seat only. Lead weights cannot be in blocks larger than 5kg, each of which must be secured by 8mm bolts and 60mm washer.

The wearing of weight belts by the Driver is forbidden.

Any kart/Driver combination found to not meet the minimum weight shall be excluded from that part of the meeting in which the irregularity was detected. The owner and Driver shall be reported to the Stewards of the meeting for further penalty.

D9: Numbers

The number plate must be at least 200mm H x 200mm W. The relevant colours shall be:

125cc Stock Honda:	PLATE: Red	NUMBER: Yellow
---------------------------	-------------------	-----------------------

The numbers must be at least 170mm high and of 20mm stroke width. They shall be fitted to both front and rear of each kart. The front number shall be attached to the bubble or Nassau Panel. A third number plate shall be mounted on the side of the kart facing the timekeepers/lap scorers. The side number shall be positioned in the area:

- No more than 500mm in front of the centreline of the rear axle;
- With the lower edge of the numbers above a horizontal line drawn through the top edge of the rear tyre;
- The plate itself must be vertical and parallel to the centreline of the kart.

National Superkart Champions in each class as well as second and third placegetters are allocated the use of the number 1, 2 and 3 respectively as their racing number in that class for the period during which they are National Champions or placegetters. The colours must be as specified for that class.

D10: Cooling

Radiator is free in size and make.

Only one radiator shall be mounted and shall be located on the left side of the driver's seat within the kart's side pod perimeter.

An inline thermostat is allowed.

All karts, if not fitted with a sealed cooling system, must be fitted with a catch tank of at least 250ml capacity to retain radiator overflow. Glycol-based coolants are prohibited.

Radiators must not be placed in front of the pedals or behind the rear bumper, however may be mounted atop of the rear bumper. Radiator caps shall be lock wired or pinned to prevent removal during racing.

D11: Fuel

Only fuels as defined by Technical Regulations - Fuel* shall be used, with the Superkart Gearbox Classes permitted to use the following fuel types :

- (i) "Pump Fuel" as defined by regulations F3
- (ii) "Racing Fuel" as defined by regulation F4
- (iii) Approved Fuel as defined by (a) and (b) below :
 - (a) VP Racing Fuels CR99
 - (b) PowerPlus 100+

**see Section 'F' at the very end of these regulations.*

It is permitted to add to the fuel commercially-available two-stroke oil lubricants that produce two-stroke fuel within the provisions of Tech Regs-Fuel. Additives not described as such upon proprietary fixed labelling are specifically prohibited, and any performance boosters incorporated in the two-stroke oil is deemed to be illegal under these rules.

D11.1: Fuel Tanks

Each fuel tank shall be firmly fixed to the chassis or the floor tray and not by any temporary system of attachment. It shall be constructed in such a way that neither it nor any fuel pipes, which shall be flexible, present any danger of leakage during the competition. The tank shall be fitted with a male connector to accept the fuel line, which shall be wired or clamped.

In each Superkart it is mandatory to install the fuel tank between each main tube of the chassis-frame, ahead of the seat and behind the rotation axis of each front wheel, in accordance with the following conditions:

- Fuel shall be delivered from the fuel tank to the fuel pump only by gravity and/or by atmospheric pressure.
- The tank may be constructed of any leakproof material. Each steel tank shall be manufactured from sheet minimum 0.7mm thick.
- Flame-retardant material is recommended. Maximum capacity of any fuel tank: 18 litres.
- Taps are optional. If fitted, they must be within easy reach of the Driver when seated in the kart.
- Each tank and each fitting shall not project beneath the floor pan.

D12: Transmission

Only six-speed transmission is allowed, all components shall be of OEM CR125. Transmission bearings shall be steel material only.

Polishing of gears is not allowed.

Ratios of the six gears are as follows:

First	14/33	2.357
Second	15/28	1.863
Third	19/29	1.526
Fourth	21/27	1.286
Fifth	23/26	1.130
Sixth	24/24	1.000

The primary drive gear attached to the crankshaft is a 20-tooth gear and the primary driven gear incorporated as part of the OEM 1999 CR125 clutch basket is a 63-tooth gear.

D13: Engine

The procedure for engine measurements is detailed in Appendix A to these regulations.

The engine shall be the 1999 Honda CR125 - commonly known as 1999 Honda CR125 karting kit motor. Initial identification is by marking of JEOIE on the lower left engine casing.

All engine parts shall be of Original Equipment Manufacturer (OEM) by Honda and any of its auxiliary components shall not be modified in any way from the original manufacturer's specification unless expressly noted under these regulations.

Adjustments to components that are specifically designed for that purpose shall not be construed to be a modification (ie, carburettor float level, jets, needles, adjustment screws, spark plugs, etc).

The kick starter and its mechanism may be removed and transmission cover plugged.

The engine's right rear cylinder nut and right side head nut shall be replaced with longer fasteners. These fasteners shall have a minimum 4mm pre-drilled hole to allow 'event' engine sealing by the Chief Scrutineer or his nominee. Any competitor may be excluded from taking part in competition until such compliance allowing their engine to be sealed in the above manner.

Non-technical items are the battery, fuel line, fuel filter, radiator, radiator hoses, clamps, ancillary mounts, fasteners, circlips, washers, sprockets, drive chain and cables.

Supercharging / Turbocharging of engines is forbidden.

D13.1: Gasket & Seals

The engine gaskets and seals are non-technical items, except for the cylinder head gasket, cylinder base gasket, exhaust flange base gasket and reed valve manifold gasket as detailed within their subsections. All seals shall be the same size and diameter as OEM.

D13.2: Crankcase

The crankcases shall be stock 1999-2002 OEM CR125 Honda cast with "JE01E" on the lower rear left side engine case.

A hole shall be drilled and threaded to accommodate the fuel pump pulse line.

The crankcase may be externally "clearanced" around the sprocket area to accept a larger front drive gear. No other machining or modifications allowed to engine cases.

Factory grinding may be present in the transfer area around the main bearing lubrication holes. No polishing or grinding shall be present on the shape of the transfers which must present its original casting pattern.

1999-2002 crankcase identification can be determined by the transfer layout in Figure D.

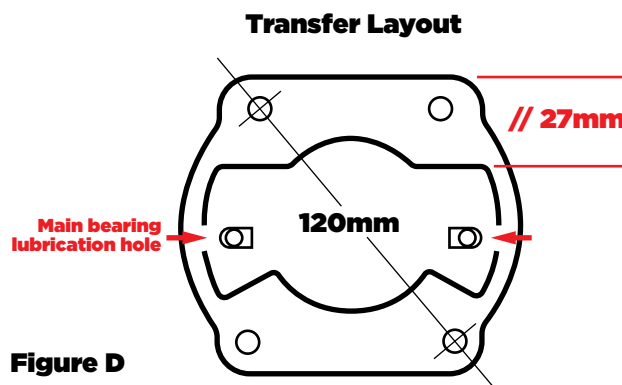

D13.3: Cylinder

The cylinder shall be a completely stock 1999 OEM CR125 P/N: 12110-KZ4-J10 as cast with no modifications.

Exhaust power valve ports shall be plugged.

Aftermarket power valve plugs may be modified to achieve desired fit. No machining or grinding to any portion of the exhaust port is permitted. No modifications such as porting, decking or replating of the cylinder is permitted.

Minor factory grinding of the cylinder walls may be present prior to the original Nikasil process. Any grinding evident after the original Nikasil process is considered a modification.

Original bore size is 54.00mm; any normal wearing to cylinder above this size is acceptable. Length of cylinder must be 84.15mm +/- 0.05mm.

The cylinder can be identified by the port layout in Figure E.

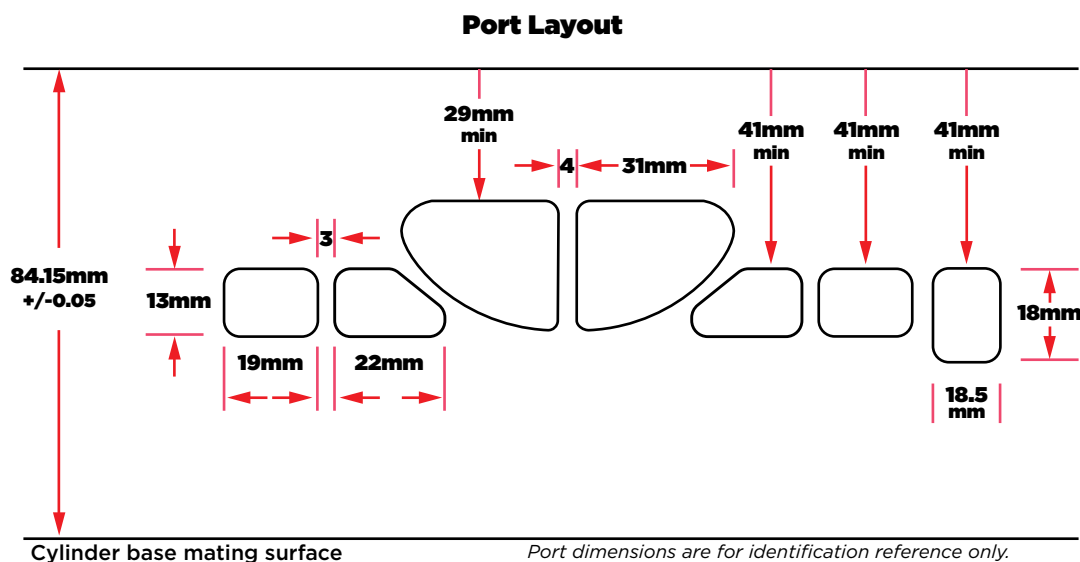

Cylinder may be spot faced where the four cylinder nuts secure the cylinder to the engine cases.

Cylinder base gasket shall be the OEM CR125 P/N: 12191-KZ4-J00 identified as being yellow in colour on one side, tan in colour on the other. Thickness of OEM CR125 base gasket is 0.5mm thick. If so desired, aftermarket base gaskets of varying thickness may be added to the OEM CR125 base gasket to achieve any combined thicknesses above 0.5mm.

D13.4: Cylinder Head

The cylinder head shall be OEM CR125 P/N 12200-KZ4-J00 with no machining or modification to the OEM combustion chamber volume, shape or dimensions whatsoever. The head is identified as cast with markings "KZ4" and either "E-4 or E-3".

The combustion chamber profile shall match when checked using the official "Stock Honda" head profile gauge tool. Only one cylinder head gasket can be used and shall be OEM CR125 P/N 12251-KZ4-701, thickness = 0.25mm.

D13.5: Piston Assembly

Only the OEM 1999 CR125 piston assembly shall be used. The OEM piston P/N 13110-KZ4-506, OEM piston ring P/N 13121-KZ4-A91, OEM piston pin P/N 13111-KV3-000 and OEM upper rod bearing P/N 91103-KZ4-B01 shall all remain stock without any modification/s. The piston can be identified as cast with "ART", is of flat top design, and has a window on the inlet side with no lubrication holes for the exhaust bridge. The ring is of 1mm thick design. The design of the piston pin is of 47mm long with an external diameter of 15mm. The design of the upper rod bearing is of 17.15mm wide.

D13.6: Crankshaft

Crankshaft assembly shall be OEM 1999 CR125 P/N 13300-KZ4-B00. No material may be added or removed from the crank wheels or connecting rod. Connecting rod shall be OEM with no modification, lightening or polishing. For identification purposes, the connecting rod is cast with "KZ4A" and ignition side of crank wheel is stamped with "G". All crankshaft assembly components and rod bearing shall be OEM 1999 CR125. The OEM CR125 rotor key shall remain in place with no modification to the key or crankshaft keyway.

Slip fitting of crankshaft journals is permitted. Only OEM CR125 P/N 91002-KY4-901 crankshaft main bearings can be used. The bearing journals may be polished for slip fit onto crankshaft.

D13.7: Clutch

Only stock OEM CR125 clutch basket P/N 22100-KZ4-700, clutch centre P/N 22120-KS6-010 and pressure plate P/N 22351-KS6-000 and shall be used as manufactured. All seven OEM clutch friction disks P/N 22201-KS6-700 and all six clutch plates P/N 22321-KA3-710 shall be installed. No modifications allowed to any component.

D13.8: Water Pump

Water pump shall be OEM 1999 CR125 and used to circulate water as intended. No modifications to impeller or housing of any kind. No external or axle driven water pumps are allowed.

D13.9: Air Filter

The carburettor shall be equipped with a purpose air cleaner/filter of choice.

D13.10: Carburettor

Only a stock Keihin 38mm PWM carburettor shall be used. Carburettor is cast with PWM on its body. No polishing, grinding, machining or modification to any internal passages. No additional internal or external performance modifications allowed.

The maximum standard carburettor bore measurement will be determined at the engine side of the slide. Control point for measuring purposes is the first 10mm of the Venturi diameter downstream from the slide. This 10mm wide zone shall not exceed 38.6mm in diameter.

D13.11: Carburettor Boot

The carburettor boot shall be OEM CR125 P/N 16221-KZ4-A10 and not be modified. This 30 degree boot shall be identified as marked with “KZ4M”.

D13.12: Reed Valve

Reed cage shall be stock OEM CR125 P/N 14100-KZ4-J11 of six-petal design. No material shall be added or removed from the reed cage. Reed stops shall be as per 1999 OEM CR125. Bending the stops to fit into an unaltered reed throat of crankcase is allowed. Removal of material from reed stops is not allowed. The reed valve layout can be identified using Figure F.

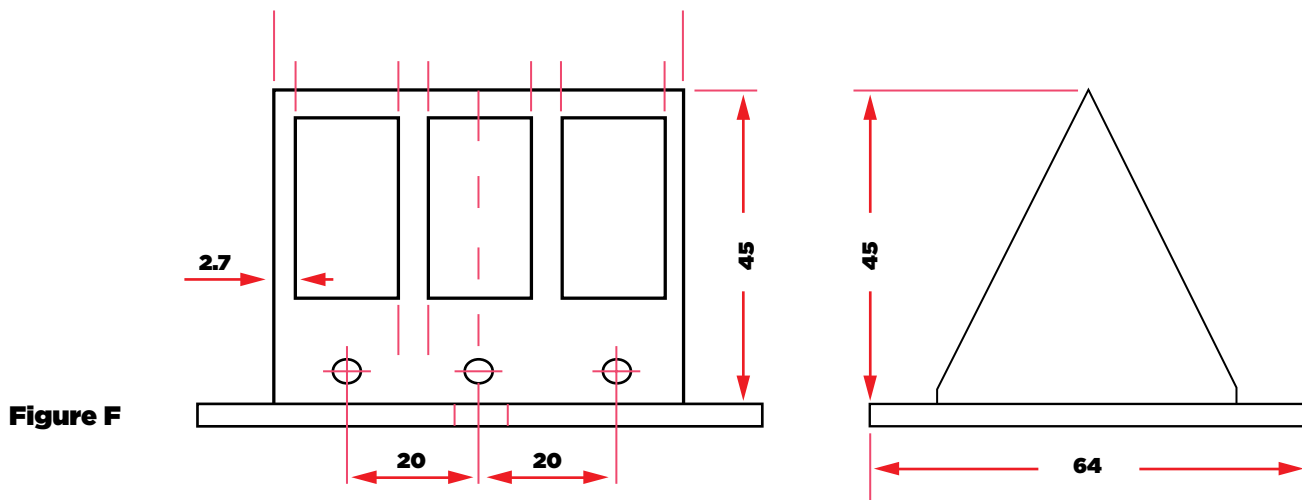

For longevity reasons, aftermarket replacement reed petals are allowed, including mono reeds and stiffeners. This allows reed petals to be fitted to the unaltered OEM CR125 P/N 14100-KZ4-J11 reed cage. A reed valve manifold gasket must be used and it shall only be 1x OEM CR125 P/N 14132-KZ4-620 identified as being yellow in colour on one side, tan in colour on the other. Thickness of reed valve manifold gasket is 1mm thick +/- 0.1mm.

D13.13: Fuel Pump

Only the Mikuni DF52 series (round type, 35 litres/hour) or Dellorto P34 PB2 P/N: D11023 (55 litres/hour) fuel pump allowed. No pump around system is allowed. Fuel Pump shall be driven by pulse pressure in the motor.

D13.14: CDI

The Capacitive Discharge Ignition (CDI) shall be stock OEM 1999 CR125 P/N 30410-KZ4-J11 that Discharge Ignition (CDI) shall be stock OEM 1999 CR125 P/N 30410-KZ4-J11 that displays Denso Part Number “071000-1410 KZ4R” on the box.

Race officials reserve the right for competitors to randomly swap CDI's prior to racing. CDI's are to be marked with competitor's name and returned to rightful owner on completion of the race meeting.

D13.15: Ignition Coil

The ignition coil shall be stock OEM CR125 P/N 30500-GY8-901 which is marked with GY8 1G3961 on its body. The HT coil wire is free; the spark plug cap shall be NGK TB05EMA.

D13.16: Spark Plug

The spark plug manufacturer is open but shall be commercially available. The maximum spark plug thread length is 20mm; thread size M14 x 1.25 pitch. The spark plug washer shall not be removed. The gap of the electrode may be adjusted.

D13.17: Generator & Flywheel

The generator and flywheel assembly shall be stock OEM CR125 P/N 31100-KZ4-J11. The flywheel shall contain the factory identification marks "KZ4R 03200-9360". The flywheel and crank key shall remain in place as originally indented with no modifications. The lower right side of the stator base plate shall contain factory marking "KZ4R". The stator plate shall not have any modifications. The left-hand lower limiting plate on the stator shall have the SKUSA timing plate installed. Any attempt to exceed the SKUSA timing plate adjustment amount is not permitted. No modifications allowed to the stator plate hold down bolts or the SKUSA plate. No other modification to any other ignition components that changes the static timing beyond what the SKUSA plate allows/ intends.

D13.18: Ignition Harness

No additional components shall be electrically connected to the CDI or Coil. Only an inductive RPM sensor/ wire for tacho readout shall be used.

The engine harness "kill switch" wires may be lengthened to facilitate mounting of the engine kill switch. Engine kill switch shall only be of toggle action and function to completely stop the engine. The use of a momentary action or push button engine kill switch is expressly forbidden.

All other ignition harness wires and connectors shall remain original OEM without any modification except in case of repair to the coil spade connector or coil grounding ring. These repairs shall only be made identically purposed as originally intended.

D13.19: Exhaust

The exhaust pipe chamber shall only be the RLV R4 (Part # 6830) without modification, using either the RLV silencer 1" inlet x 12" body length or the M4 silencer 1" inlet x 12" body length. No dimensional modification allowed to either silencer however repacking of silencer is allowed as required.

The addition of an exhaust gas temperature sensor is allowed to the exhaust pipe but the hole shall be plugged if exhaust temperature sensor is not used.

It is recommended that all exhaust springs be tie wired to prevent falling on the track.

D13.20: Exhaust Flange

Exhaust flange is open to allow the use of an aftermarket oring flange for greater convenience and sealing of the exhaust system. Any aftermarket flange shall meet the OEM 1999 CR125 exhaust flange dimensions for the opening and overall length as per Figure G.

No spacers shall be used to adjust exhaust flange length when fitted to the cylinder. No pipe spacers shall be slipped in the pipe or over the exhaust flange. The exhaust length shall not be adjustable by any means when the exhaust pipe is fitted to the flange. If an exhaust flange base gasket is used, it shall only be one gasket of OEM CR125 P/N 18291-KZ4-700. Aftermarket exhaust flanges that incorporate oring sealing design to its base is acceptable.

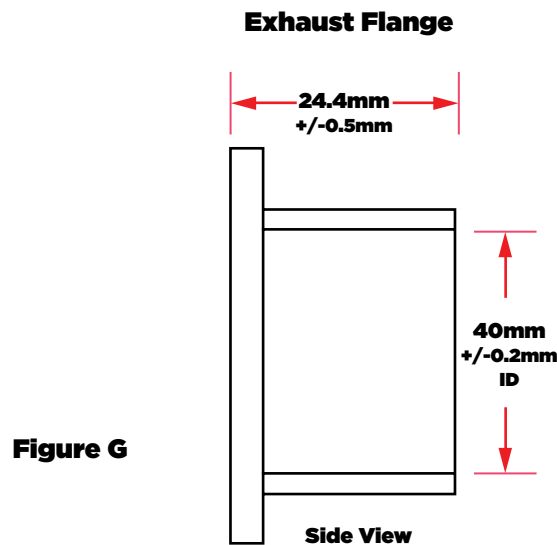

D13.21: Starter Motor

Electric starters can be fitted as an option only to be used for the sole purpose of starting the engine and must not be seen to have any performance gains advantage.

D13.3 - Engine Measuring Procedure and Specifications

Piston Squish Height:

Rotate the flywheel to bring the piston close but not at Top Dead Centre. Insert 1.5mm thick solder through spark plug opening making sure that the solder reaches the cylinder wall above one side of the piston pin. Roll engine over top dead centre and measure the flattened part of the solder. Using calipers, the squish height shall be greater than 1.27mm using the 1.5mm thick solder.

If the squish is less than 1.27mm, perform this step again to confirm. If the squish is still less than 1.27mm, this suggests that the engine does not conform to these regulations. Further inspection in engine measuring procedure shall determine the cause/s.

Combustion Chamber Profile:

Remove the cylinder head. Using the supplied Official Stock Honda Australia 1999 CR125 Combustion Chamber Profile Gauge, inspect parabola of chamber dome and squish recess for apparent gaps.

The profile gauge shall match the cylinder head profile. Competitor may clean off carbon build up with abrasive pad if required. The spark plug portion of the profile gauge stem shall not protrude above the spark plug- sealing surface.

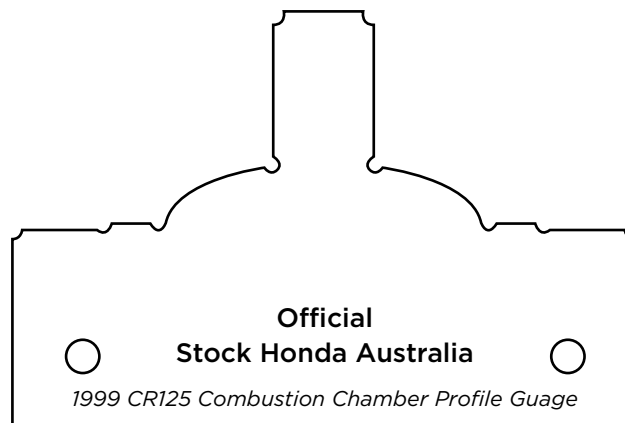

Cylinder Head Gasket:

Remove and measure the thickness of the cylinder head gasket using calipers. It shall be black in colour and of tin construction to measure a thickness of 0.25mm +/- 0.0025mm, OEM only.

Cylinder Length:

Remove the cylinder from the engine cases. Measure distance between the top and bottom of the cylinder's machined surfaces using calipers. The cylinder length shall measure 84.10 minimum to 84.20 maximum, with no modifications.

Port Inspection:

If ports appear substantially different to the cylinder port layout in Figure E, the Technical Inspector should follow up with a close inspection for any evidence of grinding to the port sizes.

Any disqualification should be based on obvious evidence of modification to the cylinder. There must be no replating of cylinder evident for any reason.

Port Height to Cylinder Top:

Exhaust Ports - Minimum Distance > 29mm

The 1999 CR125 exhaust ports have a height that is controlled by the machined operation of the exhaust valve which is very accurate in controlling port location.

Using the supplied Official Stock Honda Australia 1999 CR125 Port Height Check Gauge, insert the Exhaust side (29mm) onto the cylinder top surface in line with the exhaust port. Inspecting through the base of the cylinder, the gauge end shall not extend into the edge of the Exhaust Port opening. Check both ports at their highest points.

125cc STOCK HONDA

Note: Exhaust valves are plugged and these plugs are a non-tech item. Plugs may be ground and shaped to blend the flow along the exhaust passage. All modifications to plug must be done prior to installation within cylinder. The inspection shall not indicate any grinding to the cylinder.

Inlet Ports - Minimum Distance > 41mm

Using the supplied Official Stock Honda Australia 1999 CR125 Port Height Check Gauge, insert the Inlet side (41mm) onto the cylinder top surface in line with an Inlet port. Inspecting through the base of the cylinder, the gauge end shall not extend into the edge of the Inlet Port opening. Check all Inlet ports at their highest points.

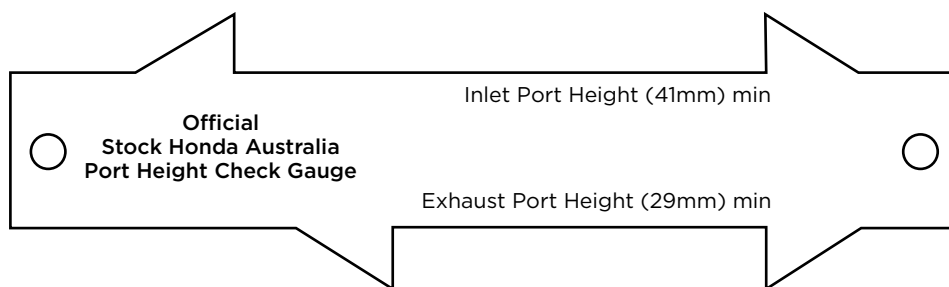

Piston Inspection & Dimensions:

Only the OEM 1999 CR125 piston can be used and cannot be replaced for any other piston. This piston can be identified as cast with "ART" on the inside skirt, is of flat top design, and has a window on the inlet side with no lubrication holes for the exhaust bridge.

Slide piston pin out of piston with no more than 6mm protruding. Using the caliper slide, measure the depth from the top of the piston to the top of the piston pin. This length shall measure 20.5mm +/- 0.05mm.

Remove the Piston Ring from the piston and using calipers, measure the thickness of the piston ring. This thickness shall measure a min of 0.96 mm.

Remove the Piston Pin from the piston and using the calipers, measure the length of the piston pin. This length shall not measure less than 46.5mm long. The diameter of the piston pin shall also be of 15mm design.

Cylinder Base Gasket(s):

Remove the cylinder base gasket/s. The engine must have the minimum requirement of 1x OEM 1999 CR125 base gasket identified as being yellow in colour on one side, tan in colour on the other. This base gasket is of 0.5mm thick in design when measured with the caliper. Any additional base gaskets included to the OEM base gasket described is allowed.

Crankcase & Crankshaft Assembly Inspection:

Rotate the crankshaft towards TDC. The connecting rod must be of uniform gold/brown colour with no polishing evident and display a cast marking of "KZ4A".

The ignition side of the crank wheel must be stamped with a "G", evident when the crank wheel is close to TDC. Inspect the crankcase transfer area for modifications with respect to the specified regulations.

Carburettor:

Inspect carburettor for any modifications. Control measurement as outlined in these regulations.

Carburettor Boot & Reed Block:

Inspect carburettor boot for any modifications. It must have KZ4M cast externally on the black rubber boot.

Inspect reed block for any modifications. The body will be of gold/yellow colour with no grinding evident. The pedal windows must have a black rubber coating without any evidence of grinding. OEM reed stops must be fitted.

Exhaust Pipe Chamber / Muffler:

The exhaust pipe is stamped on its rear cone from the inside with "RLV R4H". The pipe must not show any signs of modification from its unique manufactured formation. The muffler fitted must comply with the specified regulations.

Ignition:

Inspect the CDI, Ignition Coil, Generator and Flywheel for any visual modifications and ensure they conform to their respective regulations.

The SKUSA timing plate is machined with identification on its body and is anodised in blue. Using the official supplied SKUSA plate; a direct comparison can identify any modifications, specifically to the adjusting slot or mounting holes.



Identification of SKUSA timing plate

Gear Ratio:

With engine drive sprocket removed, install the degree wheel to the drive shaft of the engine.

Select gear and rotate the crankshaft to take up the load within the gearbox.

Once established and the degree wheel is set, the degree wheel shall rotate the following angles for each gear indicated below after exactly three revolutions of the crankshaft. If measurement fails within the tolerance, retry above procedure and/or ensure correct gear is referred to.

First	145 degs	+/- 1 deg
Second	184 degs	+/- 1 deg
Third	225 degs	+/- 1 deg
Fourth	266 degs	+/- 1 deg
Fifth	303 degs	+/- 1 deg
Sixth	343 degs	+/- 1 deg

***NGB SUPER
HEAVY***

NGB HEAVY

NGB LIGHT

NGB JUNIOR

E1: Chassis

IDENTIFICATION:

Each chassis must be marked with a unique identification number/code in a visible position on a non-removable main rail or member. This number/code shall be by permanent incident or impression of numerical and/or alpha characters and shall be recorded in the kart's log book.

DIMENSIONS:

The wheelbase must be at least 1000mm and not more than 1060mm. The track must be at least two-thirds of the wheelbase. The overall length must not exceed 2400mm.

CONSTRUCTION:

The frame must be of all metal construction. Circular section tubing only or maximum of one main rail not round. Maximum diameter for chassis tubing is 35.5mm (inclusive of paint). Maximum rear axle diameter: 50.0mm The only stub axle mounting system permissible is as per Figure A.

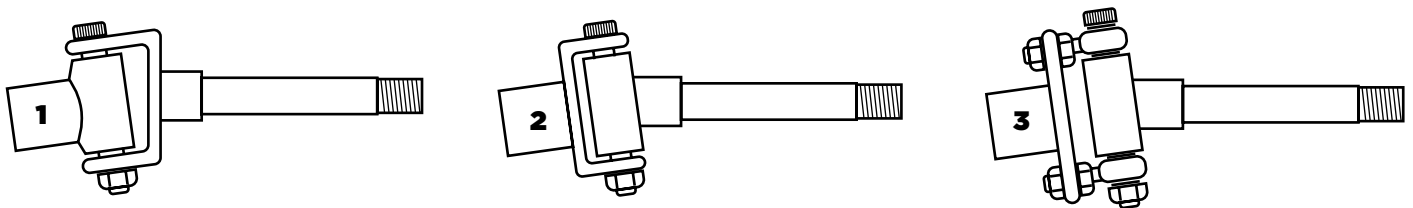

Figure A

TRANSPONDER:

Timing transmitters when fitted shall be located with the whole of the unit and mounting behind the front axle centreline in the straight ahead position with nothing metallic between the transponder and the ground.

BUMPERS:

Each kart must be fitted with bumpers front and rear. No component of the kart (other than the front fairing) may extend past either the front or rear bumpers, but may be mounted on or attached to the bumpers.

Each rear bumper shall be composed of at least one bar with a minimum diameter of 18mm and a minimum wall thickness of 1.5mm in the area between the chassis main rails; the lowest bar shall be located at a height to ground not exceeding 170mm. The rear bumper unit must be fixed to the chassis frame in at least two points.

Rear wheel protection is mandatory. Minimum width shall be 1,080mm The rear bumper maximum width shall not exceed the dimension between the outer flanges of the rear wheels regardless of the rear track setting.

Rear bumper overhang shall not exceed 400mm behind the rear axle centreline. The outer ends must be located behind the rear wheels, and:

- Any support struts or bars shall not have sharp or angular parts at the extremities;
- The outer ends shall comprise a minimum 120° tubular bending with a minimum radius of 50mm that returns back to the mounting leaving no exposed tube end/s;
- May be fitted in an angled, horizontal or vertical plane;
- The rear wheel protection bar/s shall be located within an area between 80mm and 260mm height to ground.

Alternatively, CIK-approved rear bumpers are also allowed

SUSPENSION:

Any suspension device is prohibited.

E2: Controls

PEDALS:

Whatever the position of the pedals, they must not protrude forward of the chassis, including the bumper.

THROTTLE:

The throttle must be operated by a pedal equipped with a return spring.

The carburettor must incorporate a throttle return spring.

****Hand controls:**

For the operation of the throttle and brakes are subject to the approval of the MA Technical Department. Such controls shall be identified in the kart's Log Book. These controls shall only be permitted for use by Competitors with individual disabilities.

STEERING:

Steering must be effected by the operation of a full wheel or aircraft type wheel, which has a full metal frame.

Straight handle-bars are forbidden.

Detachable steering wheels are permitted provided that they meet all other requirements and are approved by the scrutineers of the meeting.

Steering stops may be fitted.

The steering must be direct acting through a steel steering shaft of at least 16mm diameter if solid; or 19mm diameter if tubular having a minimum wall thickness of 2mm for steering wheel attachment.

The steering wheel boss must be manufactured of metal. Solid material, e.g., nylon or hardwood, must be inserted through the steering column where the steering boss bolt passes through, in order to prevent the column collapsing when the bolt is tightened. The steering shaft shall have a failsafe system to prevent it being pulled from the lower bush or bearing. All steering linkage assembly bolts and nuts must be cottered, lock wired, or fitted with self-locking nuts (including king pin bolts).

The tie rods must be of at least 8mm OD steel rod, 10mm OD by 2mm steel tube, or 10mm OD aluminium rod, or 12mm OD by 2.6mm aluminium alloy tube. In all female components of all steering rod ends and steering tie rods, there must be an inspection hole of 1mm diameter drilled 8mm from the open end. When assembled the inspection hole must be covered by thread.

All bolts must be of at least 6mm diameter, of high tensile steel with a shear strength of not less than 6KN. All tie rods must have "Rose" joints or similar aircraft type universal joints.

SWITCHES:

125NGB shall use the standard Rotax wiring loom with an ignition switch.

Control switches for electrically powered devices and accessories must be located forward of the Drivers elbow in the normal seated driving position, and be accessible to trackside officials with the Driver seated. The allowable mounting areas are confined to; an area beside the forward part of the seat; the Nassau panel/ bubble area; or on the steering wheel. Switches may be toggle, slide or push-pull type, and shall be individually identified as to on/off position and function. Grouped switches shall be arranged so that all are 'off' and 'on' in the same direction or position.

These switches shall be clearly marked by a symbol showing a red spark in a white-edged blue triangle shown on the bodywork outer surface.

**RAIN LIGHTS:**

Rain lights are mandatory for Superkarts. They shall be a unit approved by the FIA or CIK. Tail lights must be powered by a sealed battery and controlled from the cockpit by a waterproof switch. The centre point of the light face must be in an area located 350-600mm from the ground and not more than 100mm either side of the centre line of the kart.

It must be in working condition throughout the meeting. It must be switched on when the race is declared "wet" by the Clerk of the Course or when wet weather tyres are fitted.

E3: Seat

Laydown-style seats are not allowed.

The seat must be so designed that the Driver is well located to resist movement towards the side or front when cornering or braking. It must be firmly attached to the frame by at least four mountings of adequate strength.

The use of a neck brace is encouraged. The Driver must be able to see over the top of the steering wheel when seated in his normal position in the kart. The Driver's legs must occupy the front half of the kart. It is required that the reinforcement of the seat mounting points on the seat body with metal spacers be at least 1.5mm thick and 80mm minimum diameter

E4: Floor Tray

Each kart must be fitted with a flat floor tray, made of rigid material which extends from the front of the seat to the front of the kart only, which covers the whole width of the kart between the outer edges of the main longitudinal frame rails and which is no wider at any point than the longitudinal frame rails; if perforated, the holes must be of less than 10mm diameter. It may have a single hole of no more than 35mm to facilitate steering column access.

E5: Bodywork

Bodywork is permitted on 125cc Non-Gearbox Classes. Such body work must respect the following conditions:

- nose cones, bubbles and side pods, mirrors and numberplate/mounting components are allowed;
- all bodywork, excluding mirrors, forward of a vertical plane, drawn through the centre line of the front wheels in their straight-ahead position and at right angles to the centreline of the kart, must fall within the area of the template described in Figure B;

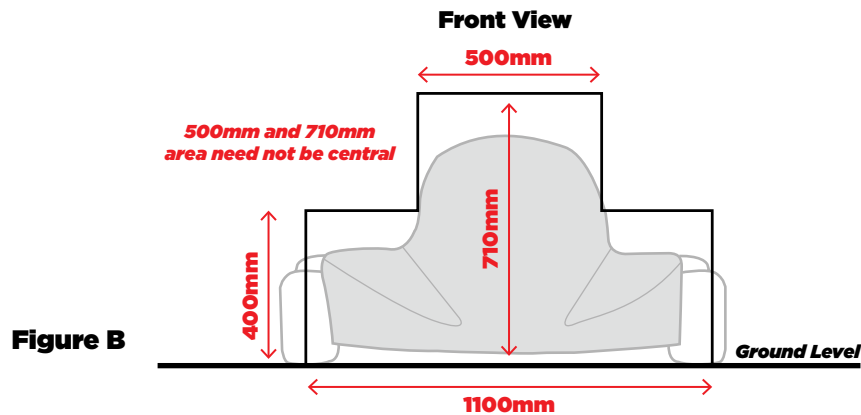

No bodywork rearward of this vertical plane shall extend further than 300mm rearward of that plane; be more than 710mm above the ground, be closer than 300mm to the ground, nor wider than 500mm as shown by the template described in Figure C.

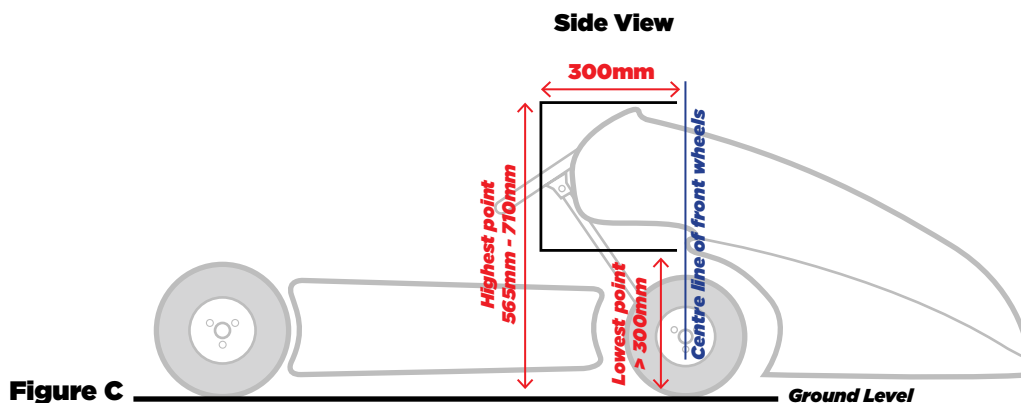

A minimum front fairing / bubble / Nassau panel height is set at 565 measured from the ground to any and all points up to 125mm either side of the centre line of the fairing/bubble/ Nassau. This is to restrict the development of the laydown style chassis.

Side pods are compulsory and must comply with the following compulsory Technical Specifications (refer Figure D).

They must under no circumstances be located either above the plane through the top of the front and rear tyres or beyond the plane through the external part of the front and rear wheels (with the front wheels in the straight ahead position). In the case of a “Wet Race”, the side pods may be located outside the plane passing through the outer edge of the rear wheels.

They may not be located inside the vertical plane through the two external edges of the wheels (with the front wheels in the straight ahead position) by more than 40mm.

They must have a ground clearance of 25mm minimum and of 60mm maximum.

The surface of the side pod must be uniform and smooth; it must not comprise holes or cuttings other than those necessary for their attachment.

Gap between the front of the side pod and the front wheel: 150mm maximum.

Gap between the back of the side pod and the rear wheel: 60mm maximum.

No part of the side pods may cover any part of the Driver seated in his normal driving position.

The side pods must not overlap the chassis-frame seen from the underneath.

On the outer side they must comprise a vertical surface (with a tolerance of $\pm 5^\circ$ in relation to the theoretical vertical plane) with a minimum height of 100mm and a minimum length of 400mm located immediately above the ground clearance.

They must not be able to hold back water, gravel or any other substance.

They must be solidly attached to the side bumpers.

Materials: side pods shall be made of non-splinterable plastic.

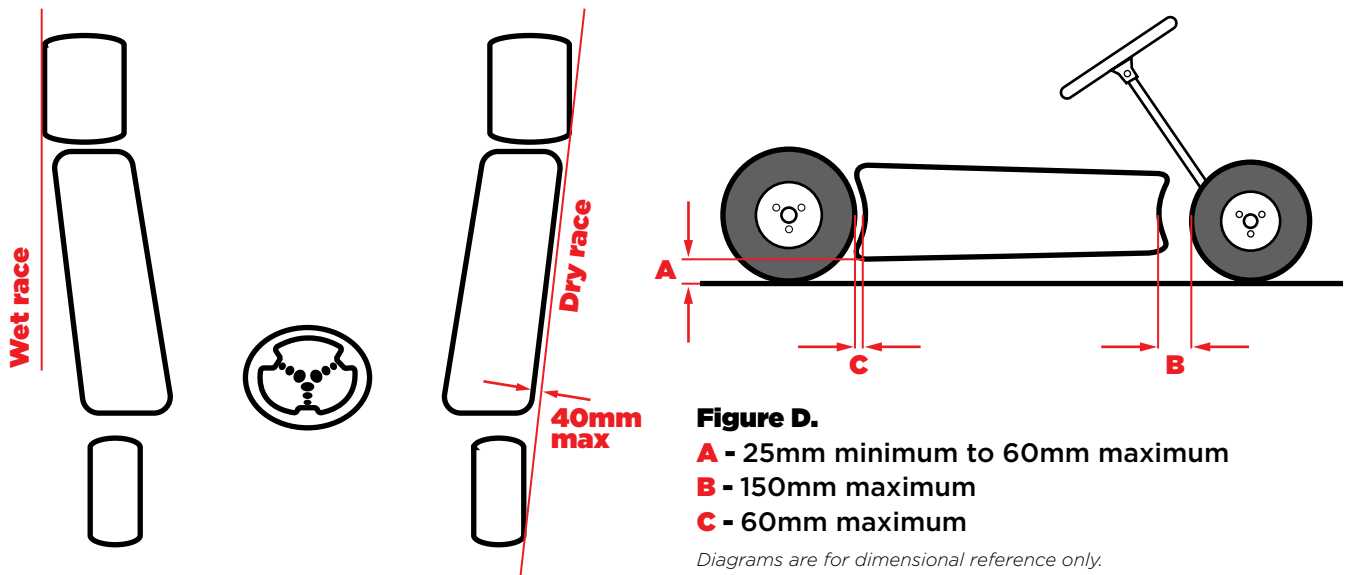

HEIGHT:

The maximum height of any part of the kart shall not exceed 710mm from the ground except for a structure solely designed as a head restraint with no possible positive aerodynamic effect.

BODY WORK:

The bodywork is made up of all parts of the kart that are in contact with air, and shall include fairings, bubble, side pods, floor tray and aerodynamic aids or wings. Bodywork does not include the air box, fuel tank, seat and number plates, and mechanical parts defined elsewhere. The bodywork must be structurally sound and finished without any sharp edges that could cause injury to a Competitor. Air vents, ducts or passages formed in bodywork or as separate elements to aid cooling or supply airflow to components shall be arranged so as not to include recessed surfaces in bodywork openings and soft and/or rolled radius to leading edges on scoops. There shall be no external protrusions beyond the vertical surface line of the side bodywork faces.

Composite materials: Composite materials are not permitted save for the construction of seats, fairings, bubbles, chain guards, number plates, rear side plates, mirror housings and the floor tray.

FAIRINGS:

The fairings are free forward of the steering wheel but must not cover the Driver rearward of the steering wheel when seated in the kart.

They must be completely hollow except for strengthening panels.

Fairings must be of safe and sound construction and must be securely fastened to the frame. They must be firmly fixed in position and not be adjustable by any means whilst the kart is in motion.

The material is restricted to:

- Glass reinforced epoxy or polyester resin;
- Vacuum-formed ABS at least 2mm thick or comparable non-shatterable material.

Fairings must be easily removable for scrutineering.

BUBBLE:

Perspex, plexiglass or fibreglass bubbles, of at least 1.2mm thickness may be fitted, but may not extend more than 75mm above the top of the steering wheel.

AREOFOILS/WINGS:

Not permitted on 125cc Non-Gearbox karts.

MIRRORS:

Mirrors are optional.

E6: Brakes

Brakes must be foot operated and provide efficient braking to at least the two rear wheels. Where there is free play at the ends of the axle keys a hose clamp or other positive mechanical method of key retention is required. All exposed brake pad mounting bolts must be drilled and lock wired.

Brake cables, of multi-strand steel wire, must be of at least 2.25mm diameter. Cables must be fastened by a machine swage or by positive clamps which do not cut into the cable. Clamps must contact both main strand and return strand in two places at each end. Electrical connectors or similar devices are not permitted.

Brake rods must be of at least 6mm diameter, of solid steel. It is recommended that a secondary actuating method be securely fitted which shall operate the brake master cylinder/s in the event of the detachment or failure of the primary link component/s fitted between the pedal assembly and the brake master cylinder/s assembly.

Brake hoses, lines and fittings are to be of suitable pressure line materials designed specifically for hydraulic use. Brake lines shall be connected to components and fittings using male type supporting connections. The use of female type compression olive fittings alone is prohibited.

Brake calliper and master cylinder mounting bolts must be of high-tensile steel, and must be drilled and lock wired, or be secured by self-locking nuts.

The use of carbon fibre disc rotors in Superkart racing is prohibited.

Must consist of a single disc and caliper acting on the rear axle. Front wheel brakes are prohibited.

E7: Wheels & Tyres

WHEELS:

5" diameter wheels.

TYRES:

Competitors are restricted to one set of four marked dry and one set of four marked wet weather tyres, (two front and two rear) for the duration of the event except as approved by the scrutineers. When tyre marking is appropriate, it shall be carried out by the scrutineers prior to the start of qualifying/racing sessions of the race meeting. Only those tyres may be used for the remainder of the race meeting, save that one front and/or one rear tyre may be replaced at the scrutineers' discretion.

Tyres shall be pneumatic, with or without tubes, with a maximum outside diameter of 350mm. Retreaded or remoulded tyres are prohibited.

All wheels shall revolve on ball or roller type bearings. Cast iron and plastic wheels are forbidden. Front wheels or hubs on stub axles must be retained by a self locking nut. Rear wheels and front wheels mounted to hubs must be retained by bolts or studs with nuts which must be a minimum of Grade 8.8. Axles must be steel.

The use of hand-grooved tyres is prohibited.

The use of any form of tyre treatment is prohibited.

Tyres **must** be selected from:

DRY	Dunlop DGM / DGH / DFH
	Maxxis HG3
	Hoosier R60B
	Bridgestone YLR Rok
SUPER HEAVY	<i>Control Tyre</i> Dunlop DFM
WET	Free (<i>must be fitted to 5" rims</i>)

All 4 tyres fitted must be of the same brand and compound.

Wet weather tyres shall be used when a race is declared "Wet" and maybe used at all other times. When used, they maybe any brand of wet weather tyre fitted to a 5" diameter rim is permitted.

VALVE CAPS:

All tyre/wheels must use metal valve caps at all times. These caps used must be sufficient design to maintain tyre integrity in case of valve mechanism failure.

E8: Weight

The minimum combined kart/Driver weight for Superkart events shall be as follows:

NGB SUPER HEAVY	205kg*
NGB HEAVY	185kg*
NGB LIGHT	165kg
NGB JUNIOR	140kg

****Maximum kart only weight of 105kg***

All ballast must be securely fastened to the chassis or seat only. Lead weights cannot be in blocks larger than 5kg, each of which must be secured by 8mm bolts and 60mm washer.

The wearing of weight belts by the Driver is forbidden.

Any kart/Driver combination found to not meet the minimum weight shall be excluded from that part of the meeting in which the irregularity was detected. The owner and Driver shall be reported to the Stewards of the meeting for further penalty.

E9: Numbers

The number plate must be at least 200mm H x 200mm W. The relevant colours shall be:

NGB SUPER HEAVY	PLATE: Yellow	NUMBER: Royal Blue
NGB HEAVY	PLATE: Blue	NUMBER: Yellow
NGB LIGHT	PLATE: White	NUMBER: Red
NGB JUNIOR	PLATE: Orange	NUMBER: Black

The numbers must be at least 170mm high and of 20mm stroke width. They shall be fitted to both front and rear of each kart. The front number shall be attached to the bubble or Nassau Panel. A third number plate shall be mounted on the side of the kart facing the timekeepers/lap scorers. The side number shall be positioned in the area:

- No more than 500mm in front of the centreline of the rear axle;
- With the lower edge of the numbers above a horizontal line drawn through the top edge of the rear tyre;
- The plate itself must be vertical and parallel to the centreline of the kart.

National Superkart Champions in each class as well as second and third placegetters are allocated the use of the number 1, 2 and 3 respectively as their racing number in that class for the period during which they are National Champions or placegetters. The colours must be as specified for that class.

E10: Cooling

Radiator: One (1) only, genuine Rotax aluminium radiator is permitted.

COOLING AREA	Height:	290mm
	Width:	133mm
	Thickness:	32mm

Any radiator produced by Rotax for the Rotax Max FR125 engine complying with the above dimensions is permitted.

Only thermostats supplied for Rotax Max FR125 as OEM by BRP Rotax GmbH may be used

All karts, if not fitted with a sealed cooling system, must be fitted with a catch tank of at least 250ml capacity to retain radiator overflow.

Glycol-based coolants are prohibited.

E11: Fuel

Only fuels as defined by Technical Regulations - Fuel* shall be used, with the Superkart NGB Classes permitted to use only the following fuel type :

(i) "Pump Fuel" as defined by regulations F3

*see Section 'F' at the very end of these regulations.

It is permitted to add to the fuel commercially-available two-stroke oil lubricants that produce two-stroke fuel within the provisions of Tech Regs-Fuel. Additives not described as such upon proprietary fixed labelling are specifically prohibited, and any performance boosters incorporated in the two-stroke oil is deemed to be illegal under these rules.

E11.1: Fuel Tank

Each fuel tank shall be firmly fixed to the chassis or the floor tray and not by any temporary system of attachment. It shall be constructed in such a way that neither it nor any fuel pipes, which shall be flexible, present any danger of leakage during the competition. The tank shall be fitted with a male connector to accept the fuel line, which shall be wired or clamped.

In each Superkart, it is mandatory to install the fuel tank between each main tube of the chassis-frame, ahead of the seat and behind the rotation axis of each front wheel, in accordance with the following conditions.

Fuel shall be delivered from the fuel tank to the fuel pump only by gravity and/or by atmospheric pressure. The tank may be constructed of any leakproof material. Each steel tank shall be manufactured from sheet minimum 0.7mm thick. Flame-retardant material is recommended.

Maximum capacity of any fuel tank: 18 litres.

Taps are optional. If fitted, they must be within easy reach of the Driver when seated in the kart.

Each tank and each fitting shall not project beneath the floor pan.

E12: Transmission

Front wheel drive systems are forbidden.

Clutches are compulsory.

All crank case drain plugs must be lock wired and all other drain, indent plunger caps and filler caps must be wired.

Crank case must be fitted with a breather pipe which discharges into an overflow bottle of at least 250ml capacity. Any discharge must be contained, and not fall on to the track.

Engine sprocket and chain guards are compulsory and must effectively cover the engine sprocket and the axle sprocket down to the centre line of the axle sprocket. All chain guards must be securely attached to the kart at both ends.

All automatic methods of chain oiling and greasing are prohibited.

Where the Driver and other persons or their clothing may come into contact with a moving component that forms part of the engine or transmission, a guard must be fitted to prevent such contact occurring.

E13: Engine

The only engine permitted is the BRP Rotax FR125 Max.

Unless expressly permitted under these regulations, all engine and driveline parts must be of Original Equipment Manufacture (OEM) by BRP Rotax GmbH.

Non-technical items are battery, fuel filter, radiator hoses, clamps, pulse line, switches, ancillary mounts, fasteners, circlips, washers, bearings, spark plug, gaskets, O-rings, springs, seals, clutch drum, engine sprocket, rings, starter motor and clutch flywheel. No alteration from the original manufacturer's specification is permitted to fit a non-technical item.

Displacement:

125.0cc maximum.

Combustion chamber insert:

Only Rotax part number 223 389 or 223 389 1 or 223 389 2 may be used. The name Rotax or 'made in Austria' must be cast into the combustion chamber insert. No additional material may be added except to repair the spark plug thread and or spark plug sealing surface. All machined surfaces may be re-machined. The insert must retain both squish band and spherical combustion chamber. An 'O-ring' must be fitted.

Spark plug thread length:

The maximum spark plug thread length is 20mm.

Piston:

Only pistons which are OEM and comply with the following regulations may be used.

(a) Coated or uncoated, aluminium, cast piston with one and only one 1.0mm rectangular piston ring. The piston has to show on the inside the words "ELKO and "Made in Austria" in the casting.

(b) Machined areas are: top crown of piston, outside diameter, one groove for the piston ring, bore for gudgeon pin, inside diameter at bottom end of piston. No other surfaces are machined.

Gudgeon Pin:

Only OEM gudgeon pins or gudgeon pins which comply with the following measurements may be used and must be made of magnetic steel:

Length	45.6mm max +/- 0.45mm
External Diameter	15.0mm -0.003mm
Internal Diameter	10mm max +0.1 -0.2mm

Cylinder:

Only cylinders supplied by Rotax and complying with the following regulations may be used. Replating is permitted.

Maximum Bore	54.035mm <i>measured 10mm above exhaust port</i>
---------------------	--

Cylinder must be marked with Rotax logo. Cylinder base must be marked with manufacturer's identification code: 223 997 or 223 996 or 223 993. Machining of this cylinder is not permitted. No additional machining of ports or passages. Cylinder must have official Formula Rotax Australia stamp on the inlet face. Junior class to use only cylinder without exhaust power valve. Cylinder has to be marked with ROTAX logo and identification code: 223 999 or 223 998 or 223 994

Length of Cylinder	87mm <i>with +0.1 / -0.05mm tolerance</i>
---------------------------	---

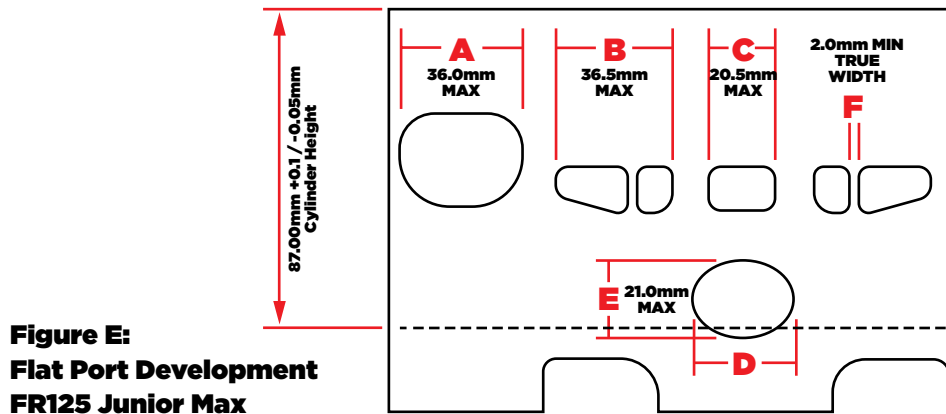

Cylinder base gasket/s:

Must be dimensionally the same size and shape as original equipment and shall not have the effect of decreasing the size of the transfer ports.

Inlet system:

No material may be added and no grinding or machining is permitted to any part of the inlet system including the manifold and reed valve assembly.

The manifold must carry the manufacturer's name ROTAX and identification code: 267 915.

The reed valve assembly must carry the manufacturer's name ROTAX and identification code: 224 387 or 224 389. The reed valve assembly must be equipped with two petal stops and two reeds, each having three petals.

Thickness of reeds	0.6mm +/-0.08mm
Reed block gasket / spacer thickness	4.0mm max

The addition of one Rotax reed block gasket, maximum of 1.0mm thick, between the carburettor manifold and the reed block is permitted.

Exhaust power valve:

No modifications are permitted to the exhaust power valve. The original spring must be fitted. No external adjustment or blocking to this device whilst the engine is running is permitted. Maximum thickness of power valve gasket/s is 2.0mm. Additional fasteners or securing devices may be fitted/added. The length of the exhaust valve is 36.5mm +0.2/-0.3mm. Collar width is 4.8mm +/- 0.3mm. Exhaust Valve Evolution is approved part ID253 725.

Crankshaft:

No modifications are permitted to the crankshaft.

Stroke	54.5mm +/-0.02mm
---------------	-------------------------

Balance shaft:

No modifications are permitted to the balance shaft, which must be installed and operational.

The balance shaft shall be either part number/type 237 945, 237 948 or 237 949. The minimum weight of the dry balance shaft is 355 grams for part number/type 237 945 and 255 grams for part number/type 237 948 and 237 949. Both the plastic balance gears, part number 234 431, or the steel balance gears, part number 234 436, are permitted. Balance gears must be installed and correctly aligned according to the instructions in the repair manual.

Connecting rod:

No grinding /polishing or modifications are permitted. Connecting rod must bear the manufacturer's stamp of "213" or "365" or "367" on the shaft.

Crankcase:

The two main transfer passages of the crankcase must remain untouched as supplied. The official Formula Rotax Australia stamp must be on the crankcase deck.

Ignition unit:

(i) The ignition unit must be DENSO or Dellorto digital ignition only, with no adjustment permitted or possible.

(ii) Dellorto ignition coil must be part number 666 825, Dellorto ECU must be part number 666 814 or 666 815 for the Senior Max engine and 666 812 or 666 813 for the Junior Max engine. No modification to any part of the ignition system and/or crankshaft to alter the ignition timing or rev limiter is permitted.

(iii) The DENSO ignition coil must have three pins at the terminal.

(iv) Battery make is free

Spark Plug Cap

Spark plug cap	Black NGK - TB05EMA
Spark plug cap	Red, marked 'NGK'

Carburettor:

The carburettor body, slide, needle, atomiser tube and atomiser insert (either specification 1 or specification 2 is permissible for seniors, but only specification 2 for Junior Max) and float arm must remain as originally supplied and may not be modified. No additions or machining, filing, drilling or polishing to these items, including the carburettor bore/throat, is permitted. No changes or adjustments can be made to the main jet or air bleed screw whilst the engine is running.

"VHSB34" must be cast in the housing of the carburettor.

Identification Mark	QD / QS / XS
Needle Jet	FN266 / DP267
Needle	K27 / K54 / K98 / K57
Slide	#40 / #45
Slide Insert	8.5 / 12.5
Floats	3.6gm / 4.0gm / 5.2gm

All items referred to in the table must be present and operational. Any combination of items in the table above may be fitted.

The carburettor body, slide, needle, atomiser tube (needle jet) and atomiser and float arm must remain as originally supplied and may not be modified. No additions or machining, filing, drilling or polishing to these items, including the carburettor bore/throat, is permitted.

No changes or adjustments can be made to the main jet or air bleed screw whilst the engine is running.

The size of any hole in any of the following is unregulated: main jet, needle and seat, pilot jet, pilot jet emulsion insert, choke jet. The position of the float/float arms are unregulated.

All other settings in the carburettor are free.

Fuel Pump:

Only one Mikuni DF44-211-D pulse fuel pump may be used. Fuel must be supplied directly from the pump to the carburettor by an uninterrupted fuel hose connection. The maximum length of the fuel line from the tank to the fuel pump is 1000mm, and from the fuel pump to the carburettor is 500mm.

Clutch:

The clutch must be of dry centrifugal type using genuine Rotax components unless nominated as a non-tech item; both genuine Rotax clutches are permitted. Whilst on level ground the kart (with Driver) must start to move under its own power, when the engine speed reaches 3000rpm or less. The use of the Rotax clutch pin support plate is permitted. Clutch springs are not classed as non-tech items and must be genuine Rotax components. Lubrication of the clutch is prohibited. Lightening of the clutch is prohibited.

Intake silencer:

The intake silencer as supplied by Rotax for the FR125 Max must be fitted, with no modifications permitted.

Air box:

The air filter must be in place, and be either fine or coarse type O30 filter. The silencer must be fitted with the inlet trumpets at the base of the unit. It is permissible to drill a single hole up to 8mm in diameter in the lower part of the intake silencer (in the centre of the plastic injection mark). Either type of air box may be used, comprising casing parts 225 025 and 225 015, or casing parts 225 010 and 225 020, 8mm drain hole is permitted.

Exhaust system:

The exhaust system must be as supplied by Rotax for the FR125 Max and may not be modified except for:

- (a) silencer absorption material may be replaced with a genuine part as supplied by Rotax,
- (b) addition of a single-sensor probe fitting. Welding for the purposes of repair of cracks, holes or fitting of patches only is permitted. No welding which has the effect of altering the shape of the exhaust system is permitted.
- (c) Endcap rivets must be replaced with bolts, capscrews etc. suitable for the purpose.

Junior class to use only Type B exhaust as supplied by ROTAX.

It is recommended that all exhaust springs be tie wired to prevent falling on the track.

Engine measuring:

Minimum squish clearance of 1.0mm to 1.5mm for senior Max engines and 1.2mm to 1.8mm for Junior Max engines, measured using 2mm solder or tin wire. The average of the two measurements taken from the left and right sides of the bore will be taken as the actual measurement for an engine.

Recommended tin wire ROTAX 580130.

Engine measuring for Rotax FR125 Senior/Junior Max will be done by the use of official gauges as supplied by Rotax. The gauges have been designed to make engine measuring quick and easy. If an engine fails when measured with these gauges, the Competitor may request that the engine be re-measured using normal precision measuring tools.

- (1) The profile of the combustion chamber insert has to be checked with a template (ROTAX part no. 277 390). The crack of light between the template and the profile of the combustion chamber insert has to be the same over the whole profile.
- (2) The "exhaust port timing" (distance from the top of the cylinder to the top of the exhaust port) has to be checked by means of the template (Rotax part no. 277 397). Insert the template into the cylinder, so that the template is touching the cylinder wall and that the finger of the template is located in the middle of the exhaust port (highest point). Move the template upwards, until the finger is touching the top edge of the exhaust port. Insert a feeler gauge between the top of the cylinder and the template. It must not be possible to fit the feeler gauge 0.75mm for senior Max. On cylinders marked 223 993 it is also legal if the template doesn't fit in at all.
- (3) As the piston moves towards the top of the cylinder (up-stroke only) and completely covers the exhaust port, it must be possible to insert the exhaust valve gauge (Rotax part no. 277 030) until it stops at the surface of the cylinder (a feeler gauge of 0,05 mm must not be possible to fit in at any area around).

TECHNICAL APPENDIX

Fuel

TECHNICAL REGULATIONS - Fuel

F1: General

(a) Any fuel used in a Competition must comply with the prescriptions of this Section. A fuel must be used without additives other than those permitted herein. Other than for pump fuel, the mixing of fuels from different oil companies, or of different grades and/or types of fuel from the same oil company is forbidden.

An oil company shall be deemed to be either:

- (i) a company with oil refining capacity either in Australia or Internationally;
- (ii) a company with roadside retail fuel bowser outlets within Australia; or
- (iii) a company with national distribution capability.

(b) Each Group/Classification or category or Event regulation/s must detail the fuel which is permitted in accordance with this Schedule.

(c) It is not permitted to use a fuel of any type that contains lead in any form.

F2: Commercial Fuel

A petrol, (as defined below) produced by an oil company and available for commercial sale in all States and mainland Territories of Australia.

All Commercial Fuel shall comply with the Fuel Standards. Determinations made under Section 21 of the Fuel Quality Standards Act (2000).

Fuel which is the subject of Approvals made under Section 13 of the Fuel Quality Standards Act (2000) shall not be regarded as Commercial Fuel.

F3: Pump Fuel

A Commercial Fuel (as defined above), with a maximum ethanol content of 10%. Pump Fuel must be available for sale on demand from a roadside retail bowser outlet at each of at least five separate service stations in each of at least three Australian States.

A mixture of Pump Fuels is not permitted.

F4: Racing Fuel

Unleaded racing fuel is defined as an unleaded petrol produced by an oil company in compliance with the specifications detailed in the Code. Such Unleaded Racing Fuel supplied from a drum is permissible.

F5: Oxidants

Only air may be mixed with the fuel as an oxidant. The use of Nitrous Oxide is prohibited.

F6: Additives

Any substance, other than air, incorporated into the fuel subsequent to its final blending by the producing oil company is deemed to be an additive. Nothing in the foregoing shall be deemed to prohibit the addition of water, an approved lead replacement additive or a lubricant provided that such additive does not increase the octane or cetane rating, oxygen content or specific heat content of the fuel.

F7: Fuel Testing

Fuel samples may be drawn for testing from a competing Automobile at any time during the period of time from the commencement of the Event until the vehicle is released from Parc Fermé at the conclusion of the Event, should one be organised.

It is the responsibility of the Competitor to provide the means by which a fuel sample/s may be taken from the Automobile; the method being subject to the approval of the Chief Scrutineer. Sampling requiring the disconnection of hoses containing fuel under pressure is not acceptable.

Whilst the fuel samples for testing are being taken, the Competitor, or his nominated representative, must be in immediate attendance to observe the process. Where the Competitor or his nominated representative cannot be present within a reasonable time, the Chief Scrutineer must notify the Stewards, who shall appoint a proxy observer, being an Official of the meeting, who shall act as the nominated representative of the Competitor.

For a National Championship and Series, and other Event as specified in event regulations, the Competitor must declare to the Scrutineers, at the time of sampling, the brand and type of fuel that is in the Automobile fuel tank. Any additive, including lubricants, must also be disclosed to the scrutineers. Where a permitted mixture of fuels is present, all component fuels must be declared.

Samples shall be tested according to procedures A or B below.

Test Procedure A: Testing at the Event

The Chief Scrutineer may choose to test fuel samples at the event. To this effect, one sample of fuel may be taken for testing under the conditions outlined above from each or any Automobile. The Competitor may, at their discretion, request a second sample be drawn at the same time. After being duly identified and sealed, this second sample may be retained by the Competitor**.

Testing at the event shall be limited to:

- (a) physical observation of the sample (colour, opacity)
- (b) testing using whatever specialist equipment is available at the event (e.g. electrical conductivity, density, gas chromatography etc.)

Where an infringement is raised as a result of such testing, the Chief Scrutineer or their representative must give evidence at the subsequent Stewards Hearing or Inquiry, although they will not be accorded the status of "Judge of Fact". Notwithstanding this, the Stewards will be obliged to take into consideration any evidence thus presented.

**The Competitor may use the retained sample in their defence provided that the seal of the sample retained by the Competitor is broken in the presence of the Stewards. Where the Scrutineer deems that no action is necessary, the container holding the Competitor sample shall be returned to the Competitor by the Scrutineer.

TECHNICAL REGULATIONS - Fuel

Test Procedure B:

For tests by an accredited laboratory, two fuel samples must be drawn and sealed into identified containers. The seal on each container must be affixed in such a way as to ensure the rupture of the seal upon the opening of the container. Each seal must bear identification of the Event, the name and signature of the Scrutineer taking the sample and the name and signature of the Competitor. The samples (Samples A and B) shall then be retained by the Stewards. The Sample A will then be sent to a suitably accredited laboratory. The determination of fuel type and composition shall be by comparison against a reference library of results for known fuel types determined by the method ASTM D-3710-95 (or equivalent).

Where the laboratory notifies the Stewards/scrutineers that Sample A has been found to be not in conformity with the prescriptions contained herein, the Stewards shall lodge sealed fuel Sample B with the same laboratory. Where the results of the second test Sample B corroborate the initial determination of Sample A, the fuel shall be deemed to be not in conformity with the prescriptions of the present Schedule. This finding shall be binding on any Stewards' Hearing, Appeal Tribunal or any subsequent hearing. Where a discrepancy exists between the results of Samples A and B, no action shall be taken against the Competitor.

Note: There are costs associated with fuel testing by an accredited laboratory. Prior to any testing of this nature the event organisers/promoters must be advised to inform on costs. There are special conditions associated with the transport and handling of flammable liquids which must be observed.

F8: Health Warning

All participants in motorsport are reminded that fuels, oils, lubricants and coolants are highly specialised substances. Apart from the ever-present risk of fire, participants must be aware that these agents may contain substances that are extremely dangerous to one's health if misused, inhaled or allowed into contact with human skin. Some of the components of these fuels, oils and lubricants are suspected of having the potential to cause cancer in rare instances. The use of petrol as a general cleaning and washing agent is a common misuse of a potentially dangerous substance and is not recommended.

It is advised that appropriate PPE be used when handling fuels.

TECHNICAL APPENDIX

Apparel

TECHNICAL REGULATIONS - Apparel

G1: Application

- (a) The letters in the following table represent the applicable standard as detailed in Article 2. These are referenced by apparel type and status of the competition.
- (b) The standards set out in this Section are the *minimum* requirement for the superkart events.

Helmet	C
Frontal Head Restraint	B
Flame-retardant Overalls	E
Flame-retardant Underwear	C
Flame-retardant Balaclava	D
Footwear	D
Socks	C
Gloves	D















Along with meeting these Standards the maximum age as from date of manufacture is as follows:

Helmet	10 years
---------------	----------

TECHNICAL REGULATIONS - Apparel

G2: Apparel Standards

G2.1: Helmet



Standards	Example Label	FHR Compliant
<p>A Note: For International level Events, only a helmet as specified in FIA Technical List No. 25 (Recognised Standards for Helmets) shall be accepted.</p>		
FIA 8860-2018 and 8860-2018-ABP		Yes
FIA 8860-2010		Yes
FIA 8860-2004 (Not valid level A after 31/12/2020)		Yes
FIA 8859-2015		Yes
Snell SA2010 (not valid level A after 31/12/2023) And either FIA 8858-2010 OR FIA 8858-2010 tether anchors (No. etched on the tether anchor)		Yes
Snell SA2010 (Not valid level A after 31/12/2023) and FIA 8858-2002 tether anchors (No. etched on the tether anchor)		Yes
Snell SA2015 and FIA 8858-2010 tether anchors		Yes
Snell SAH 2010 (Not valid level A after 31/12/2023) and FIA 8858-2010 tether anchors		Yes
<p>B Helmet of the Level A Standard</p>		
Snell SA2005 If used with FHR only fitted with compliant FHR tether anchors – FIA 8858-2002 or FIA 8858-2010.		Yes
BS 6658-85 A/FR If used with FHR only fitted with FHR tether anchors from the manufacturer.		Yes
SFI 31.1, SFI 31.1A, SFI 31.2A, SFI 24.1 (youth helmet standard) Level A Standard		No
Snell SA2000		No
AS/NZS1698 and updates Label may vary depending on approval body.		No
ECE 22 (with 03, 04 or 05 amendments) Label may be on the helmet strap and consist of the E mark with a number which defines the country of origin.	 <p>i.e.4 = Netherlands</p>	No

TECHNICAL REGULATIONS - Apparel



G2.1: Helmet cont'

C	Full Face Helmet of the Level A Standard		
	Full Face Helmet of the Level B Standard		
	Full Face Helmet of Snell M2000, M2005, M2010, M2015 standard (valid for Superkart competition only)		No
D		Not Mandatory	

G2.2: Frontal Head Restraint (FHR)

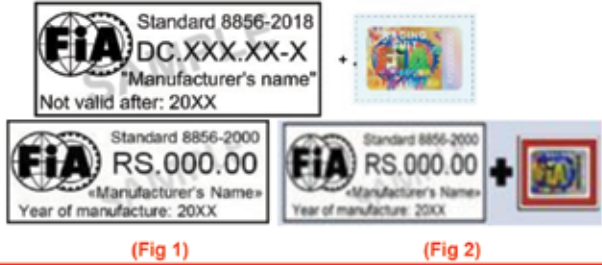

Standards	Example Label
A FIA 8858-2010 <i>Hologram compulsory on 8858-2010 yoke manufactured after 01/01/2013</i> FIA 8858-2002	
B Not mandatory, Level A standard device highly recommended	
C Not mandatory, highly recommended where circumstances are appropriate	

G2.3: Flame-retardant Overalls





Standards	Example Label
A FIA 8856-2018 <i>Hologram compulsory for all items manufactured.</i> FIA 8856-2000 <i>Manufactured before 01/01/2016 do not require a FIA hologram. (Fig 1)</i> <i>Hologram compulsory for items manufactured after 01/01/2016 (Fig 2)</i>	
B Level A; FIA 1986	
C Level A; Level B; SFI3.2A/1 (single layer) or superior SFI standard.	
D Clothing from ankles to neck to wrists. Clothing of flammable synthetic material, such as nylon, is not acceptable. Level A, B or C overalls are recommended.	
E Minimum of a CIK Level 2 Fabric Overall which must be marked as per the CIK-FIA requirements; or Leather overall, which may be one or two piece, securely fastened at the wrist and ankle and also at the waist of a two-piece suit. In each case the overall must cover the whole body from ankle to neck to wrists.	
F Minimum of short sleeve shirt/t shirt and short pants	

TECHNICAL REGULATIONS - Apparel





G2.4: Flame-retardant Underwear

Standards		Example Label	
A	FIA 8856-2018 <i>Hologram compulsory for all items manufactured.</i>		
	FIA 8856-2000 <i>Hologram compulsory for items manufactured after 01/01/2016</i>		
B	Not mandatory; FIA-standard flame-retardant underwear is recommended		
C	Not mandatory		

G2.5: Flame-retardant Balaclava

Standards		Example Label	
A	FIA 8856-2018 <i>Hologram compulsory for all items manufactured.</i>		
	FIA 8856-2000 <i>Hologram compulsory for items manufactured after 01/01/2016</i>		
B	A Level A balaclava is required, except where the driver/co-driver is wearing a helmet to Level A standard. If a Level A helmet is worn, the wearing of a flame-retardant balaclava is not mandatory, but is recommended		
C	Not mandatory; a motor sport standard balaclava is recommended		
D	Not mandatory		

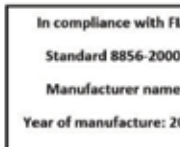
G2.6: Footwear



Standards		Example Label	
A	FIA 8856-2018 <i>Hologram compulsory for all items manufactured.</i>		
	FIA 8856-2000 <i>Manufactured before 01/01/2016 do not require a FIA hologram. (Fig 1) Hologram compulsory for items manufactured after 01/01/2016 (Fig 2)</i>		
B	Level A or shoes with leather uppers that cover the foot. Shoes which have a leather upper but which include elasticised ankle regions are acceptable (e.g. elastic-sided work boots)		
C	Enclosed shoes		
D	Abrasion-resistant footwear which covers and protects the ankles		

TECHNICAL REGULATIONS - Apparel

G2.7: Flame-retardant Socks

	Standards	Example Label
A	FIA 8856-2018 <i>Hologram NOT compulsory for socks.</i> FIA 8856-2000 <i>Hologram NOT compulsory for socks.</i>	<div style="display: flex; justify-content: space-around;"> <div style="border: 1px solid black; padding: 5px; width: 45%;"> <p>In compliance with FIA Standard 8856-2000</p> <p>Manufacturer name</p> <p>Year of manufacture: 20XX</p> </div> <div style="border: 1px solid black; padding: 5px; width: 45%;"> <p>In compliance with FIA Standard 8856-2018</p> <p>Manufacturer name</p> <p>Name of manufacturer</p> <p>Hologram N°: DC.XXX.XX-X</p> <p>Not valid after: 20XX</p> </div> </div>
B	Not mandatory; FIA-standard flame-retardant socks are strongly recommended	
C	Not mandatory	

G2.8: Gloves

	Standards	Example Label
A	FIA 8856-2018 <i>Hologram compulsory for all items manufactured.</i> FIA 8856-2000 <i>Hologram compulsory for items manufactured after 01/01/2016</i>	<div style="display: flex; justify-content: space-around;"> <div style="border: 1px solid black; padding: 5px; width: 45%;"> <p>In compliance with FIA Standard 8856-2018</p> <p>Manufacturer name</p> <p>Name of manufacturer</p> <p>Hologram N°: DC.XXX.XX-X</p> <p>Not valid after: 20XX</p> </div> <div style="border: 1px solid black; padding: 5px; width: 45%;">  </div> </div> <div style="display: flex; justify-content: space-around;"> <div style="border: 1px solid black; padding: 5px; width: 45%;"> <p>In compliance with FIA Standard 8856-2000</p> <p>Manufacturer name</p> <p>Year of manufacture: 20XX</p> </div> <div style="border: 1px solid black; padding: 5px; width: 45%;">  </div> </div>
B	Not mandatory; FIA-standard flame-retardant gloves are strongly recommended	
C	Not mandatory	
D	Abrasion-resistant gloves that cover and protect the hands and wrists (including the fingers)	

G3: Further Requirements

3.1 General:

- (a) Each driver/competing crew member shall continue to comply with the requirement of NCR 141 until such time as they exit their automobile, or for rally/road events until the completion of a competitive section/stage – refer also to Table 1.2.
- (b) Apparel shall be worn as the manufacturer intended.
- (c) Individual category or event regulations may require higher standards of apparel than those detailed in Article 1 and 2. In such cases the higher standard shall apply.

3.2 Badges and Embroider or Printing / Transfers:

The attachment of badges, use of embroidery or any printing/transfers on competitor's overalls can have a detrimental effect on the protection afforded by the garment.

- (a) Badges: For apparel complying to the FIA 8856-2000 or 8856-2018 standard, it is mandatory that all badges attached to the garment have a flame-resistant backing and be attached only with flame-resistant thread to the outer layer of the garment only. For all garments the number and size of badges should be kept to the minimum required to meet commercial and regulatory obligations
- (b) Embroidery: For apparel complying to the FIA 8856-2000 or 8856-2018 standard, it is mandatory that all embroidery be done using flame-resistant thread. Embroidery is only permitted to the outer layer of the garment. This is strongly recommended for all apparel.
- (c) Printing/Transfers: For apparel complying to the FIA 8856-2000 8856-2018 standard any printing or transfer is permitted to be done only by the manufacturer. A competitor may be asked to demonstrate proof that any printing or transfer has been done only by the manufacturer.

3.3 Helmet Requirements:

- (a) Helmets must only be full face. No open face helmets allowed.
- (b) Modifications:
 - (i) A helmet shall not be modified from its specification as manufactured except in compliance with instructions approved by the manufacturer and one of the standards organisations listed in this schedule, which certified the helmet concerned. Any item added or attached to a helmet (including any camera or camera mount) by any means shall be considered as a modification. Any modifications or additions undertaken may invalidate the helmet certification.
 - (ii) Approved modifications may include: Painting or wrapping (vinyl sticker or similar) in compliance with the manufacturer's instructions which may require proof that it has been carried out accordingly.
 - (iii) Adding or attaching of ducting for cooling purposes using components supplied by the manufacturer or in compliance with the manufacturer's instructions. Adding or attaching communication equipment using components supplied by the manufacturer or in compliance with the manufacturer's instructions.

Note: Decoration of helmets is potentially dangerous, and members are warned of the hazard of using paint on approved helmets. Paint, stickers and transfers, or surface treatments can react with helmet shell material and affect its protective capacity; therefore, where a manufacturer provides guidelines or restrictions on the painting or decoration of helmets, these must be followed, using only paint or surface treatment specified by them (air drying acrylic, polyurethane enamel or others) and preferably a painter having their approval. This is particularly important for injection-moulded shells which are not usually suitable for painting. The shell being painted should be efficiently masked as paint penetrating the interior can affect the performance of the helmet liner. Paints requiring heat curing should not be used and any process should not exceed the maximum temperature of conditioning of the helmet in the standard to which it is approved.

- (c) Frontal Head Restraints:
 - (i) The drilling of holes in helmets for the fitment of FHR tether posts shall be undertaken only by the manufacturer of the helmet or an approved manufacturer's agent.
 - (ii) Tether posts may be fitted to helmets that are pre-drilled in accordance with the FHR manufacturer's instructions.
 - (iii) The manufacturer's instructions should also be consulted for any considerations on the use of stickers and transfers.



COMMISSION INTERNATIONALE DE KARTING - FIA



COMBINAISONS HOMOLOGUEES - Partie 1 (Norme 2013-1) HOMOLOGATED OVERALLS - Part 1 (Standard 2013-1)

Demandeur <i>Applicant</i>	Pays <i>Country</i>	Type/Modèle <i>Type/Model</i>	Homologation <i>Homologation</i>	Début <i>Beginning</i>	Fin <i>End</i>	Niveau <i>Level</i>	Combinaison valide jusqu'au <i>Overall valid until</i>
Sparco SpA	ITA	Sparco K31 KS3	CIK-FIA 2013/001	07.10.2013	06.10.2018	2	06.10.2023
Sparco SpA	ITA	Sparco K32 KS5	CIK-FIA 2013/002	07.10.2013	06.10.2018	2	06.10.2023
OMP Racing SpA	ITA	OMP KS-2 Karting	CIK-FIA 2013/003	06.11.2013	05.11.2018	2	05.11.2023
OMP Racing SpA	ITA	OMP KS-1 Karting	CIK-FIA 2013/004	20.11.2013	19.11.2018	2	19.11.2023
Free Minds Srl	ITA	Freem TK114	CIK-FIA 2013/005	11.12.2013	10.12.2018	2	10.12.2023
Sparco SpA	ITA	Sparco K33 X-LIGHT	CIK-FIA 2013/006	16.01.2014	15.01.2019	2	15.01.2024
OMP Racing SpA	ITA	OMP KS-3 Karting	CIK-FIA 2013/007	04.03.2014	03.03.2019	2	03.03.2024
CONFEZIONE SABINA SNC	ITA	MIR TAZ1	CIK-FIA 2013/008	06.03.2014	05.03.2019	2	05.03.2024
CONFEZIONE SABINA SNC	ITA	MIR DIA1	CIK-FIA 2013/009	06.03.2014	05.03.2019	2	05.03.2024
Alpinestars SpA	ITA	Alpinestars K-MX 9 2014	CIK-FIA 2013/010	18.08.2014	17.08.2019	2	17.08.2024
Racewear p.e.	BLR	RLG 14 Level 1	CIK-FIA 2013/011	20.02.2015	19.02.2020	1	19.02.2025
Sparco SpA	ITA	Sparco K34 KS9	CIK-FIA 2013/012	26.08.2014	25.08.2019	2	25.08.2024
Alpinestars SpA	ITA	Alpinestars K-MX 5 2014	CIK-FIA 2013/013	18.08.2014	17.08.2019	2	17.08.2024
Alpinestars SpA	ITA	Alpinestars K-MX 1 2014	CIK-FIA 2013/014	26.08.2014	25.08.2019	2	25.08.2024
Sparco SpA	ITA	Sparco K35 Ergo-7	CIK-FIA 2013/015	16.10.2014	15.10.2019	2	15.10.2024
OMP Racing SpA	ITA	OMP KS-4 Karting	CIK-FIA 2013/016	28.10.2014	27.10.2019	1	27.10.2024
Kobra di Baronetto Paola	ITA	Kobra Winner	CIK-FIA 2013/017	11.05.2015	10.05.2020	2	10.05.2025
OFF Road Racing Gear Co., LTD	HKG	ORG Kart Suit	CIK-FIA 2013/018	21.08.2015	30.09.2020	2	20.08.2025
K1 RACEGEAR	PAK	K1 RACEGEAR K1-Retro	CIK-FIA 2013/019	18.08.2015	17.08.2020	2	30.07.2025
OMP Racing SpA	ITA	OMP KS-1R Karting	CIK-FIA 2013/020	21.09.2015	20.09.2020	2	20.09.2025
X'Zuit Apparel Limited	HKG	X'zuit Ikon 2	CIK-FIA 2013/021	31.07.2015	30.07.2020	2	30.07.2025
Sparco SpA	ITA	Sparco K36 Sparco-K3	CIK-FIA 2013/022	30.11.2015	29.11.2020	2	29.11.2025
Sparco SpA	ITA	Sparco K38 Prime KS-10	CIK-FIA 2013/023	20.02.2016	19.05.2021	2	19.05.2026
Alpinestars SpA	ITA	Alpinestars Super KMX-1	CIK-FIA 2013/024	13.07.2016	12.07.2021	2	12.07.2026
Galuppo Srl	ESP	Galuppo GK 2900 SUPRA	CIK-FIA 2013/025	26.07.2016	25.07.2021	2	25.07.2026
OMP Racing SpA	ITA	OMP K-KK7-001	CIK-FIA 2013/026	26.09.2016	25.09.2021	2	25.09.2025
Sparco SpA	ITA	Sparco K40 ROBUR KS-5	CIK-FIA 2013/027	19.09.2016	18.09.2021	2	18.09.2026
Sparco SpA	ITA	Sparco K41 X-Light KS-7	CIK-FIA 2013/028	19.09.2016	18.09.2021	2	18.09.2026
Sparco SpA	ITA	Sparco K39 Groove KS-3	CIK-FIA 2013/029	06.10.2016	05.10.2021	2	05.10.2026
Alpinestars SpA	ITA	Alpinestars K-MX9-17	CIK-FIA 2013/030	19.09.2016	18.09.2021	2	18.09.2026
Alpinestars SpA	ITA	Alpinestars K-MX5-17	CIK-FIA 2013/031	19.09.2016	18.09.2021	2	18.09.2026
HRX Srl	ITA	HRX Extra	CIK-FIA 2013/032	04.11.2016	03.11.2021	2	03.11.2026
Al Khair International	PAK	Al Khair International AK II Kart Suit	CIK-FIA 2013/033	21.03.2017	20.03.2022	2	20.03.2027
Corsa Commercial Ltda	BRA	Corsa Evokart	CIK-FIA 2013/034	20.04.2017	19.04.2022	2	19.04.2027
Taiwan Racing Products CO, LTD	TWN	Taiwan Racing Products RSK-100	CIK-FIA 2013/035	18.05.2017	17.05.2022	2	17.05.2027
Sparco SpA	ITA	Sparco K42 ROBUR EVO KS-5E	CIK-FIA 2013/036	14.07.2017	13.07.2022	2	13.07.2027
7 Ind. E Com. De Produtos para Competicoes Automobilisticas Ltda me	BRA	ULV KS01	CIK-FIA 2013/037	25.07.2017	24.07.2022	2	24.07.2027
PM Sports	PAK	Speed Race Wear	CIK-FIA 2013/038	10.01.2018	09.01.2023	2	09.01.2028
Alpinestars SpA	ITA	Alpinestars K-MX9 V2	CIK-FIA 2013/039	19.04.2018	18.04.2023	2	18.04.2028
Puma SE	DEU	Puma Kart Cat I Suit	CIK-FIA 2013/040	10.08.2018	09.08.2023	2	09.08.2028
OMP Racing SpA	ITA	OMP KS 2R.A	CIK-FIA 2013/041	18.01.2019	17.01.2024	2	17.01.2029
OMP Racing SpA	ITA	OMP KS-3.A	CIK-FIA 2013/042	18.01.2019	17.01.2024	2	17.01.2029
Free Minds Srl	ITA	Freem K19	CIK-FIA 2013/043	29.01.2019	28.01.2024	2	28.01.2029
Custom Racewear Ltd	GBR	CR X-Pro	CIK-FIA 2013/044	27.02.2019	03.11.2021	2	03.11.2026
Alpinestars SpA	ITA	KMX-3 V2	CIK-FIA 2013/045	14.08.2019	13.08.2024	2	13.08.2029
Sparco SpA	ITA	K43 Thunder	CIK-FIA 2013/046	18.10.2019	17.10.2024	2	17.10.2029
Sparco SpA	ITA	K44 Kerb	CIK-FIA 2013/047	18.10.2019	17.10.2024	2	17.10.2029
Corsa Commercial Ltda	BRA	Corsa Neo	CIK-FIA 2013/048	17.12.2019	16.12.2024	2	16.12.2029
CONFEZIONE SABINA SNC	ITA	MIR RD2	CIK-FIA 2013/049	28.01.2020	27.01.2025	2	27.01.2030
HRX Srl	ITA	Fuji	CIK-FIA 2013/050	06.03.2020	05.03.2025	2	05.03.2030
Kobra di Baronetto Paola	ITA	Kobra Winner	CIK-FIA 2013/051	07.08.2020	06.08.2025	2	06.08.2030
Marina Race S.L.	ESP	Marina Racewear Unic K-Suit	CIK-FIA 2013/052	08.12.2020	07.12.2025	2	07.12.2030
OMP Racing SpA	ITA	OMP KS-4.01	CIK-FIA 2013/053	14.12.2020	13.12.2025	1	13.12.2030
X'Zuit Apparel Limited	HKG	X'zuit Ikon 3	CIK-FIA 2013/054	24.06.2021	23.06.2026	2	23.06.2031

IMPORTANT

Rappel du Règlement d'Homologation de la CIK-FIA

Art. 8.11, 2^{ème} Partie : Conditions générales

2.1 – Domaine d'application et Niveau d'efficacité

a) activité de loisirs : niveau 1

b) activités de compétition nationale et internationale : niveau 2

Reminder of the CIK-FIA Homologation Regulations

Art. 8.11, 2nd Part: General conditions

2.1 – Field of application and levels of efficiency

a) leisure activities: level 1

b) national & international competition activities: level 2

DRIVER STANDARDS - Aus Superkart Classic

DATE: / 3 / 22	DRIVER Name & No:
INCIDENT:	
OUTCOME:	
ISSUED BY:	

DATE: / 3 / 22	DRIVER Name & No:
INCIDENT:	
OUTCOME:	
ISSUED BY:	

DATE: / 3 / 22	DRIVER Name & No:
INCIDENT:	
OUTCOME:	
ISSUED BY:	

DATE: / 3 / 22	DRIVER Name & No:
INCIDENT:	
OUTCOME:	
ISSUED BY:	

DATE: / 3 / 22	DRIVER Name & No:
INCIDENT:	
OUTCOME:	
ISSUED BY:	

DATE: / 3 / 22	DRIVER Name & No:
INCIDENT:	
OUTCOME:	
ISSUED BY:	

DATE: / 3 / 22	DRIVER Name & No:
INCIDENT:	
OUTCOME:	
ISSUED BY:	

DRIVER STANDARDS - Aus Superkart Classic

DATE: / 3 / 22	DRIVER Name & No:
INCIDENT:	
OUTCOME:	
ISSUED BY:	

DATE: / 3 / 22	DRIVER Name & No:
INCIDENT:	
OUTCOME:	
ISSUED BY:	

DATE: / 3 / 22	DRIVER Name & No:
INCIDENT:	
OUTCOME:	
ISSUED BY:	

DATE: / 3 / 22	DRIVER Name & No:
INCIDENT:	
OUTCOME:	
ISSUED BY:	

DATE: / 3 / 22	DRIVER Name & No:
INCIDENT:	
OUTCOME:	
ISSUED BY:	

DATE: / 3 / 22	DRIVER Name & No:
INCIDENT:	
OUTCOME:	
ISSUED BY:	

DATE: / 3 / 22	DRIVER Name & No:
INCIDENT:	
OUTCOME:	
ISSUED BY:	

DRIVER STANDARDS - National Festival

DATE: / 8 / 22	DRIVER Name & No:
INCIDENT:	
OUTCOME:	
ISSUED BY:	

DATE: / 8 / 22	DRIVER Name & No:
INCIDENT:	
OUTCOME:	
ISSUED BY:	

DATE: / 8 / 22	DRIVER Name & No:
INCIDENT:	
OUTCOME:	
ISSUED BY:	

DATE: / 8 / 22	DRIVER Name & No:
INCIDENT:	
OUTCOME:	
ISSUED BY:	

DATE: / 8 / 22	DRIVER Name & No:
INCIDENT:	
OUTCOME:	
ISSUED BY:	

DATE: / 8 / 22	DRIVER Name & No:
INCIDENT:	
OUTCOME:	
ISSUED BY:	

DATE: / 8 / 22	DRIVER Name & No:
INCIDENT:	
OUTCOME:	
ISSUED BY:	

DRIVER STANDARDS - National Festival

DATE: / 8 / 22	DRIVER Name & No:
INCIDENT:	
OUTCOME:	
ISSUED BY:	

DATE: / 8 / 22	DRIVER Name & No:
INCIDENT:	
OUTCOME:	
ISSUED BY:	

DATE: / 8 / 22	DRIVER Name & No:
INCIDENT:	
OUTCOME:	
ISSUED BY:	

DATE: / 8 / 22	DRIVER Name & No:
INCIDENT:	
OUTCOME:	
ISSUED BY:	

DATE: / 8 / 22	DRIVER Name & No:
INCIDENT:	
OUTCOME:	
ISSUED BY:	

DATE: / 8 / 22	DRIVER Name & No:
INCIDENT:	
OUTCOME:	
ISSUED BY:	

DATE: / 8 / 22	DRIVER Name & No:
INCIDENT:	
OUTCOME:	
ISSUED BY:	